

PIASTRA X ART. ZAS472-ZAS478

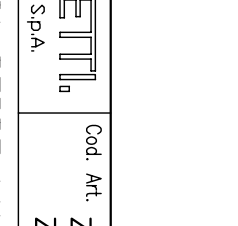
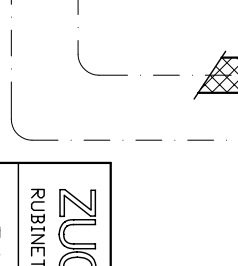
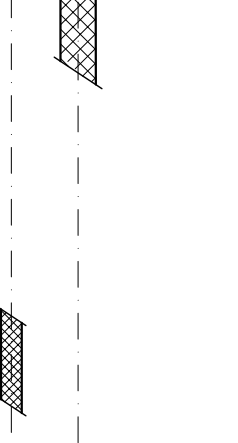
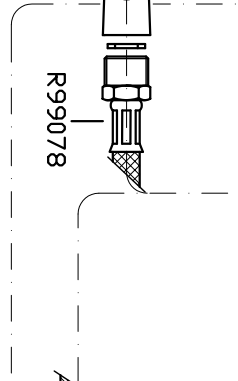
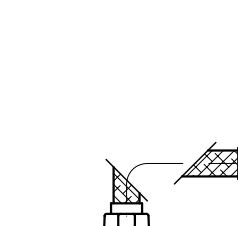
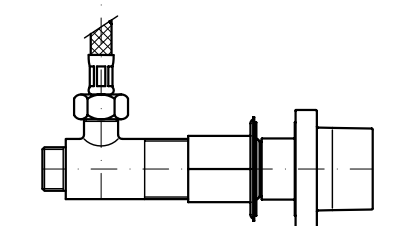
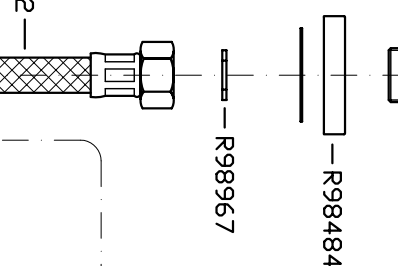
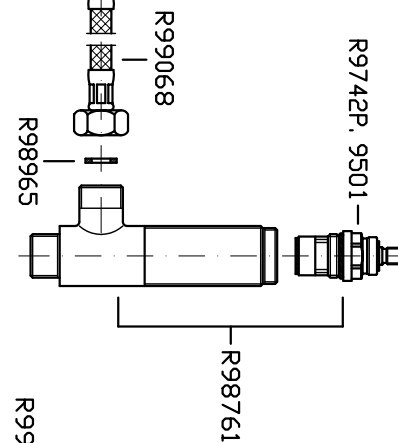
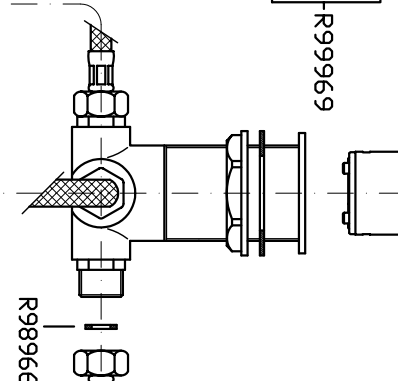
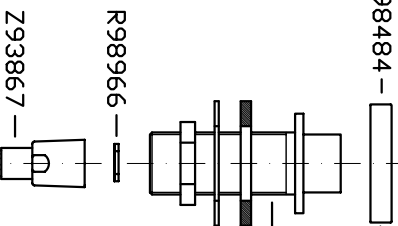
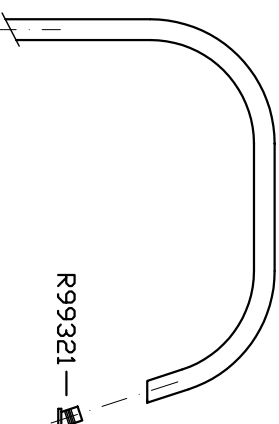
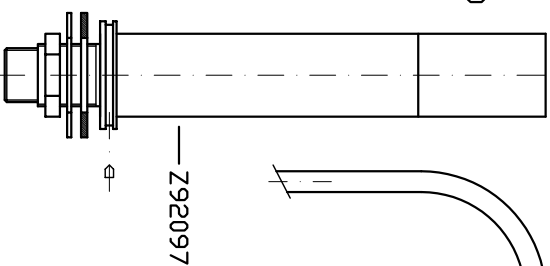
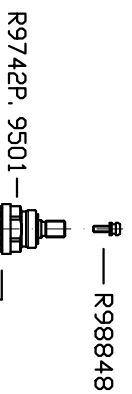
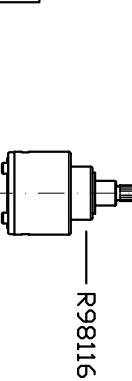
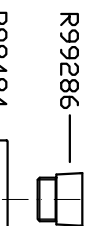
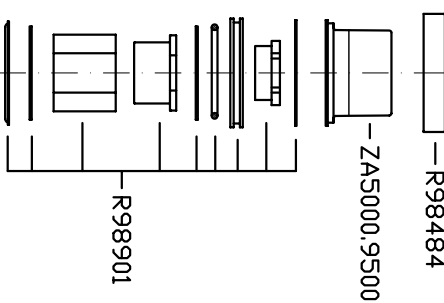
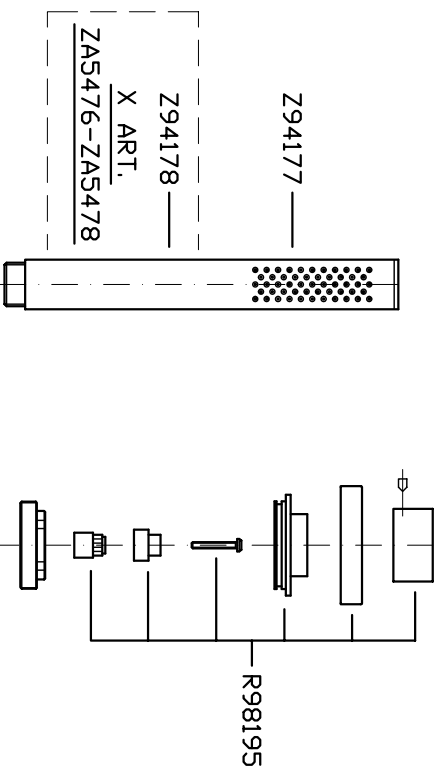

ZUCCHETTI RUBINETTERIA S.p.A.		Cod. Art. ZAS471-ZAS476
BATTERIA BORDO VASCA -3VIE-		ZAS472-ZAS478
Rev. 00	Data 16/03/11	