

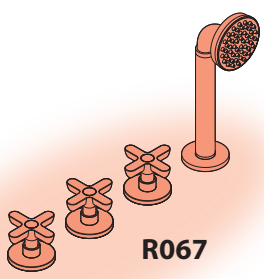

FANTINI
RUBINETTI

ICONA



R067

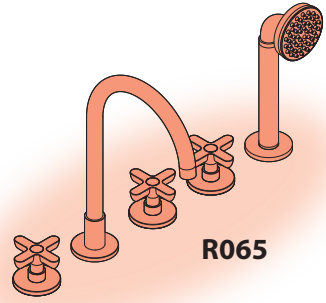

R065

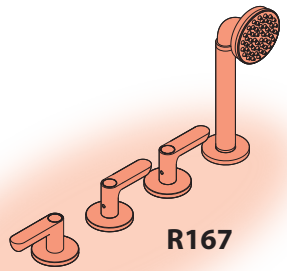

R167

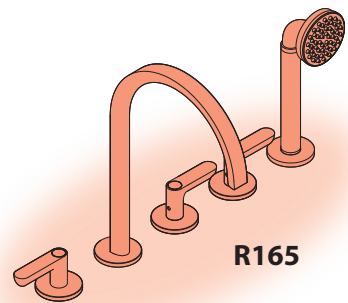

R165

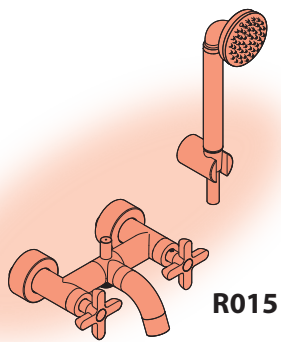

R015

R067

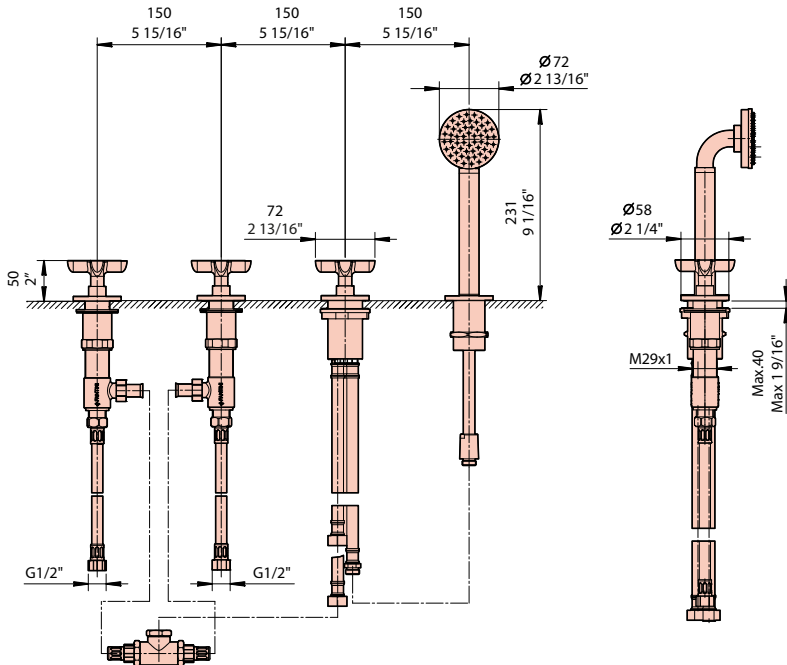

- IT** Questi miscelatori possono essere utilizzati con accumulatori di acqua calda a pressione o con scaldabagni istantanei.
- EN** These mixers can be used with high-pressure hot water accumulators or with instant water heaters.
- FR** Ces mitigeurs peuvent être utilisés avec des accumulateurs d'eau chaude à pression ou avec des chauffe-eau instantanés.
- DE** Diese Mischer sind sowohl für Heißwasserspeicher als auch Durchlauferhitzer geeignet.
- ES** Estos monomandos pueden utilizarse con acumuladores de agua caliente a presión o con calentadores instantáneos.
- PT** Esta misturadora pode ser utilizada com acumuladores de água quente sob pressão ou com esquentadores instantâneos.

R165

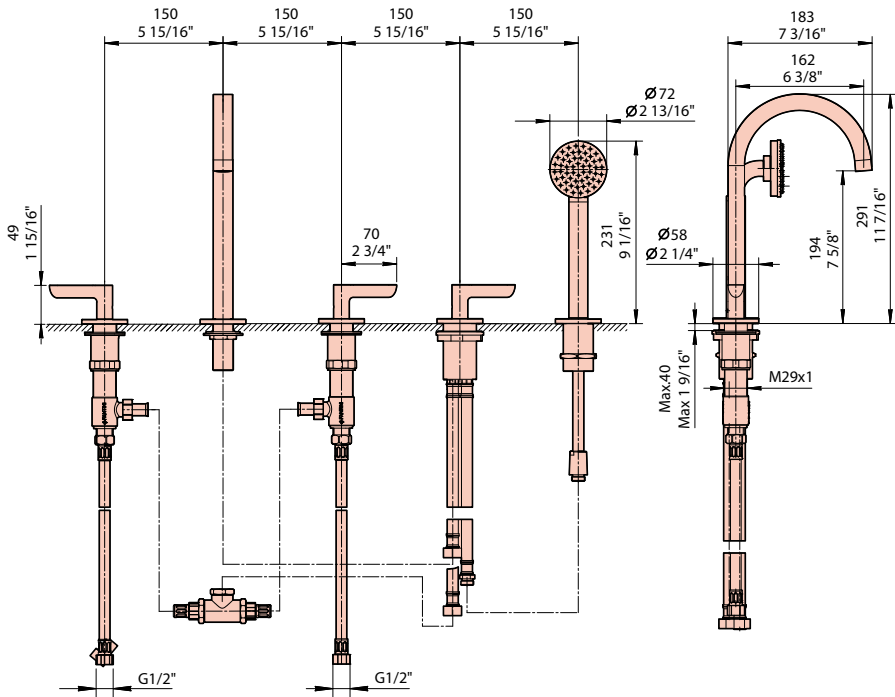

- IT** Questi miscelatori possono essere utilizzati con accumulatori di acqua calda a pressione o con scaldabagni istantanei.
- EN** These mixers can be used with high-pressure hot water accumulators or with instant water heaters.
- FR** Ces mitigeurs peuvent être utilisés avec des accumulateurs d'eau chaude à pression ou avec des chauffe-eau instantanés.
- DE** Diese Mischer sind sowohl für Heißwasserspeicher als auch Durchlauferhitzer geeignet.
- ES** Estos monomandos pueden utilizarse con acumuladores de agua caliente a presión o con calentadores instantáneos.
- PT** Esta misturadora pode ser utilizada com acumuladores de água quente sob pressão ou com esquentadores instantâneos.

R015

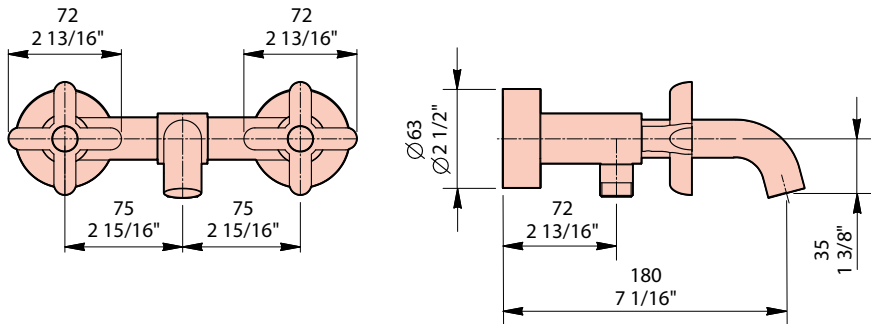

- IT** Questi miscelatori possono essere utilizzati con accumulatori di acqua calda a pressione o con scaldabagni istantanei.
- EN** These mixers can be used with high-pressure hot water accumulators or with instant water heaters.
- FR** Ces mitigeurs peuvent être utilisés avec des accumulateurs d'eau chaude à pression ou avec des chauffe-eau instantanés.
- DE** Diese Mischer sind sowohl für Heißwasserspeicher als auch Durchlauferhitzer geeignet.
- ES** Estos monomandos pueden utilizarse con acumuladores de agua caliente a presión o con calentadores instantáneos.
- PT** Esta misturadora pode ser utilizada com acumuladores de água quente sob pressão ou com esquentadores instantâneos.



IT	EN	FR	
Pressione minima	Minimum pressure	Pression minimum	1 BAR
Pressione massima	Maximum pressure	Pression maximum	10 BAR
Press. di esercizio consigliata	Reccomended working pressure	Pression optimale de service	2-5 BAR
Temperatura massima	Max. water temperature	Température maximum	80° C 176° F
Temperatura massima consigliata	Maximum water temperature recommended	Température maximum optimale	65° C 149° F
Differenza max di pressione in arrivo (calda - fredda)	Maximum in-let pressure difference (hot - cold) 1.5 BAR	Différence max. de pression d'arrivée (chaud - froid)	1.5 BAR

DE	ES	PT	
Minimum druck	Pression mínima	Pressão mínima	1 BAR
Höchste druck	Pression máxima	Pressão máxima	10 BAR
Empfehlener druck	Pression de trab. aconsejada	Press. de funcionamento recomendada	2-5 BAR
Höchste wasser Temperatur	Temperatura máxima	Temperatura máxima	80° C 176° F
Wassertemperatur Höchste einkommende	Temperatura máxima aconsejada	Temperatura máxima recomendada	65° C 149° F
Höchste einkommende Drucksunterschied (Warm - kalt)	Diferencial max. de presión de entrada (caliente - fria)	Diferença máxima de pressão na entrada (quente - fria)	1.5 BAR

- IT** Se la pressione dell'acqua è superiore a 5 bar, è preferibile installare un riduttore di pressione a monte dell'alimentazione per evitare vibrazioni e rendere regolare la regolazione della temperatura.
- EN** If water pressure is above 5 bar, it is advisable to install a flow restrictor upstream of the water supply to avoid vibrations and regulate temperature.
- FR** Si la pression de l'eau est supérieure à 5 bar, il est recommandé d'installer un réducteur de pression en amont de l'alimentation afin d'éviter toute vibration et régulariser le réglage de la température.

- DE** Wenn der Wasserdruck über 5 bar liegt, sollte möglichst ein Druckminderer vor der Zuleitung montiert werden, um Schwingungen zu vermeiden und eine gleichmäßige Temperaturregelung zu ermöglichen.
- ES** Si la presión del agua supera los 5 bar, es preferible instalar un limitador de caudal en la conducción de la alimentación para evitar vibraciones y normalizar la regulación de la temperatura.
- PT** Se a pressão da água for superior a 5 bar, é preferível instalar um redutor de pressão antes do abastecimento para evitar vibrações e tornar a regulação da temperatura regular.

UTENSILI NECESSARI - NECESSARY TOOLS - OUTILS NÉCESSAIRES
 ERFORDERLICHE WERKZEUGE - HERRAMIENTAS NECESARIAS - FERRAMENTAS NECESSÁRIAS

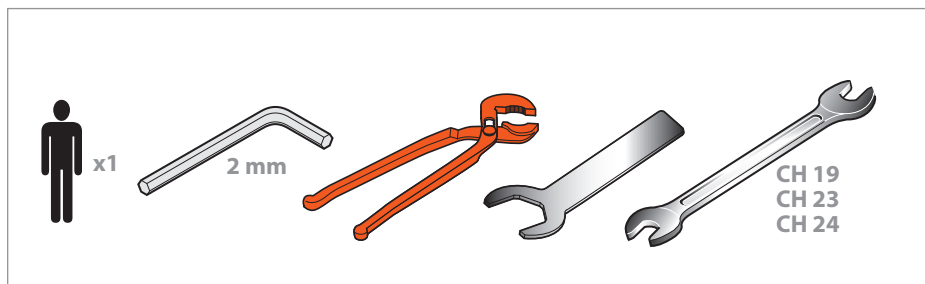

IT **INSTALLAZIONE DEI FLESSIBILI (FORNITI): avvertenze**

Utilizzare unicamente i flessibili forniti. Prima dell'installazione controllare la presenza e l'integrità delle graffiature dei flessibili da ambo i lati. Avvitare i raccordi con tenuta O.R. a mano (coppia massima di serraggio 3 Nm). Avvitare i raccordi con tenuta a guarnizione (dadi) a mano più 1/4 di giro con chiave appropriata. Il contatto prolungato con sostanze, pur blandamente aggressive, può determinare il danneggiamento della treccia ed il conseguente scoppio del flessibile. Non collegare la messa a terra dell'impianto elettrico al flessibile o ad altra condotta idraulica. Sostituire il flessibile in caso di piccole perdite. Si consiglia l'installazione di rubinetti sottolavabo con filtro.

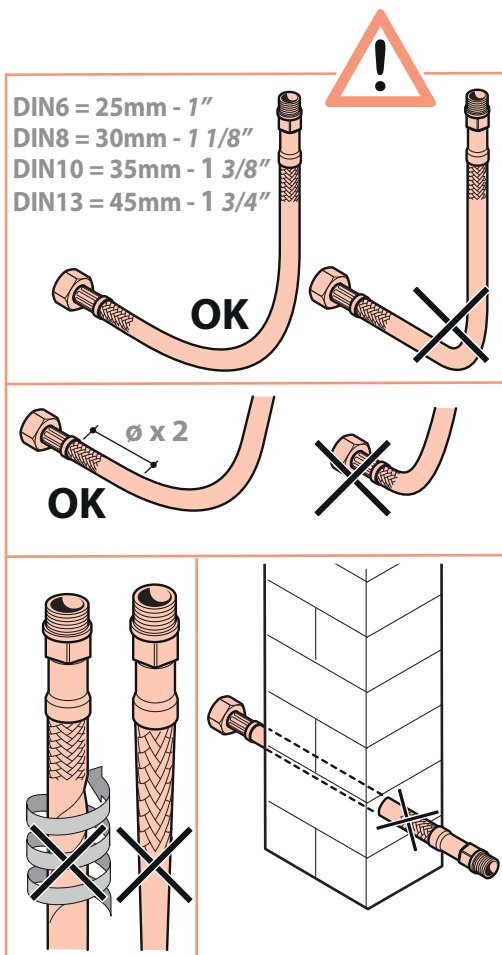

EN **INSTALLING THE FLEXIBLE HOSES (SUPPLIED): warning**

Only use the flexible hoses supplied. Check for the presence and perfect condition of the seaming on either side of the flexible hoses before installation. Screw on the connectors with an OR seal by hand (maximum tightening torque of 3 Nm). Screw on the connectors with a gasket seal (nuts) by hand and next tighten by a quarter of a turn with an appropriate spanner. Prolonged contact with substances, even blandly aggressive, may damage the braid and consequently cause the flexible hose to be damaged. Do not connect the electrical system earthing to the flexible hose or to another plumbing pipe. Replace the flexible hose in the event of small leaks. We recommend the installation of underbasin filters.

FR **INSTALLATION DES FLEXIBLES (FOURNIS) : recommandations**

N'utiliser que les flexibles fournis. Avant l'installation, contrôler que les agrafes des flexibles soient présentes et intactes des deux côtés. Visser les raccords avec joint d'étanchéité O.R. à la main (couple de serrage maximum 3 Nm). Visser les raccords avec joint d'étanchéité (écrous) à la main, plus un 1/4 de tour avec une clé appropriée. Le contact prolongé avec des substances, même si peu agressives, peut endommager la tresse avec conséquence rupture du flexible. Ne pas raccorder la mise à la terre de l'installation au flexible ou à une autre conduite hydraulique. Remplacer le flexible en cas de petites pertes. L'installation de robinets sous lavabo avec filtre est conseillée.



DE MONTAGE DER DURCKSCHLÄUCHE (IM LIEFERUMFANG ENTHALTEN): Hinweise

Verwenden Sie nur die mitgelieferten Druckschläuche. Prüfen Sie vor der Montage das Vorhandensein und die Unversehrtheit der Falze auf beiden Seiten der Druckschläuche. Schrauben Sie die Anschlussstücke mit O-Ring von Hand an (maximaler Anzugsmoment 3 Nm). Ziehen Sie die Anschlussstücke mit Dichtung (Muttern) erst von Hand und dann mit einer 1/4-Drehung durch einen geeigneten Schraubenschlüssel fest. Jeder längerer Kontakt mit Stoffen, die auch nur leicht aggressiv sind, kann zur Beschädigung des Schlauchgeflechts und somit zum Platzen des Druckschlauchs führen. Schließen Sie die elektrische Erdung auf keinen Fall an den Druckschlauch oder ein anderes Wasserrohr an. Ersetzen Sie den Druckschlauch auch bei kleinen Verlusten. Wir empfehlen Ihnen die Installation von Eckventilen mit Filter.

ES INSTALACIÓN DE LOS FLEXOS (INCLUIDOS): advertencias

Utilice únicamente los flexos incluidos. Antes de la instalación, comprobar que las conexiones de los flexos estén tengan sus juntas en los dos extremos y en buen estado. Enroscar a mano los racords con junta tórica (máximo par de apriete: 3 Nm). Enroscar los racords con junta (tuercas), antes a mano y luego 1/4 de vuelta con una llave adecuada. El contacto prolongado con sustancias mínimamente agresivas puede estropear el trenzado y, por lo tanto, provocar que se dañe el flexo. No conectar la toma de tierra de la instalación eléctrica al flexo o a otros conductos de agua. Cambiar el flexo si se detectan pequeñas pérdidas. Se recomienda instalar llaves de paso con filtro bajo el fregadero.

PT INSTALAÇÃO DOS TUBOS FLEXÍVEIS (FORNECIDOS): avisos

Utilize unicamente os tubos fornecidos. Antes da instalação, verifique a presença e integridade do grampeamento dos tubos de ambos os lados. Enrosque as uniões com vedante O.R. à mão (binário máximo de aperto 3 Nm). Enrosque as uniões com junta de vedação (porcas) à mão mais 1/4 de volta com uma chave adequada. O contacto prolongado com substâncias, mesmo se apenas levemente agressivas, pode causar danos na trança e fazer rebentar o tubo. Não ligue o fio de ligação à terra do circuito eléctrico ao tubo flexível ou a outra canalização hidráulica. Substitua o tubo flexível no caso de pequenas fugas. Recomenda-se a instalação de torneiras com filtro debaixo do lavatório.

R065 - R067 - R165 - R167

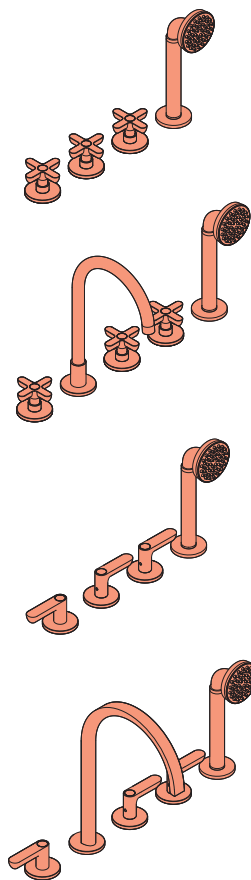

2	3	4	5	11
12	13	14	15	16
17	18			

R015

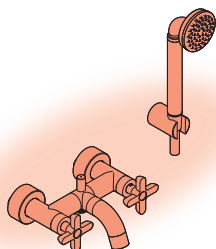

6	19	20	21
---	----	----	----

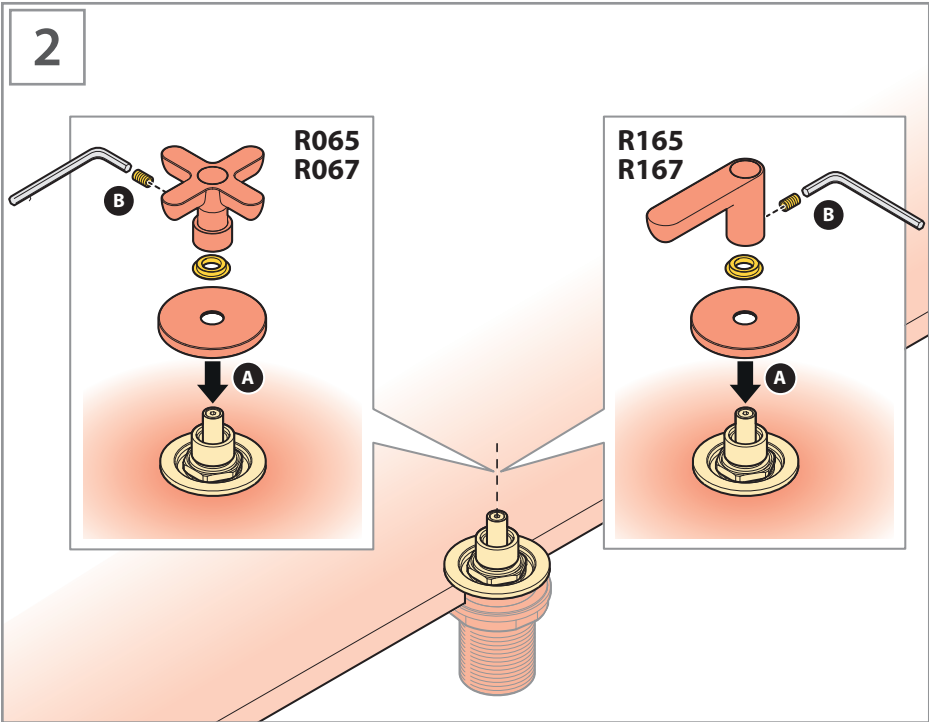
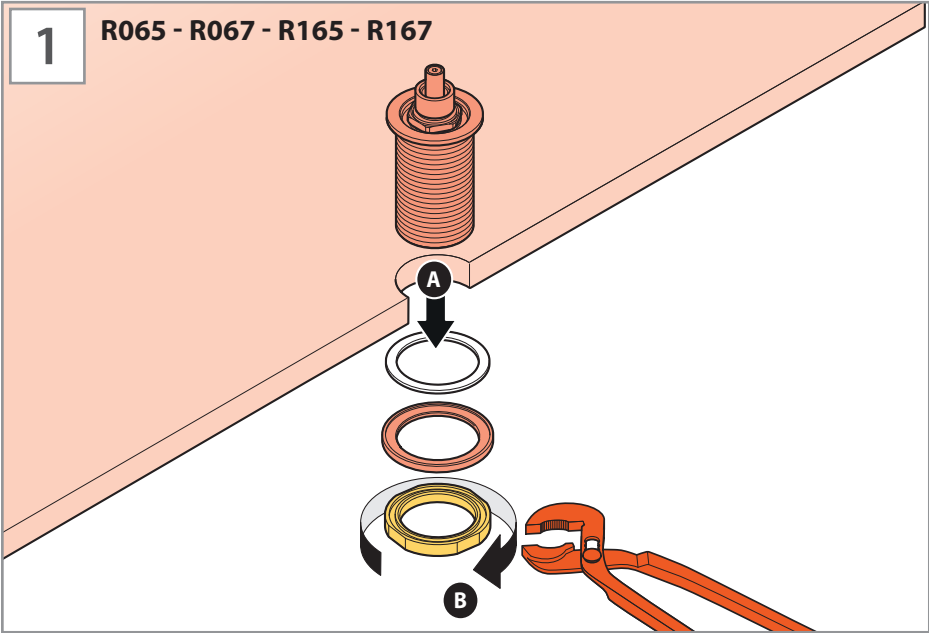

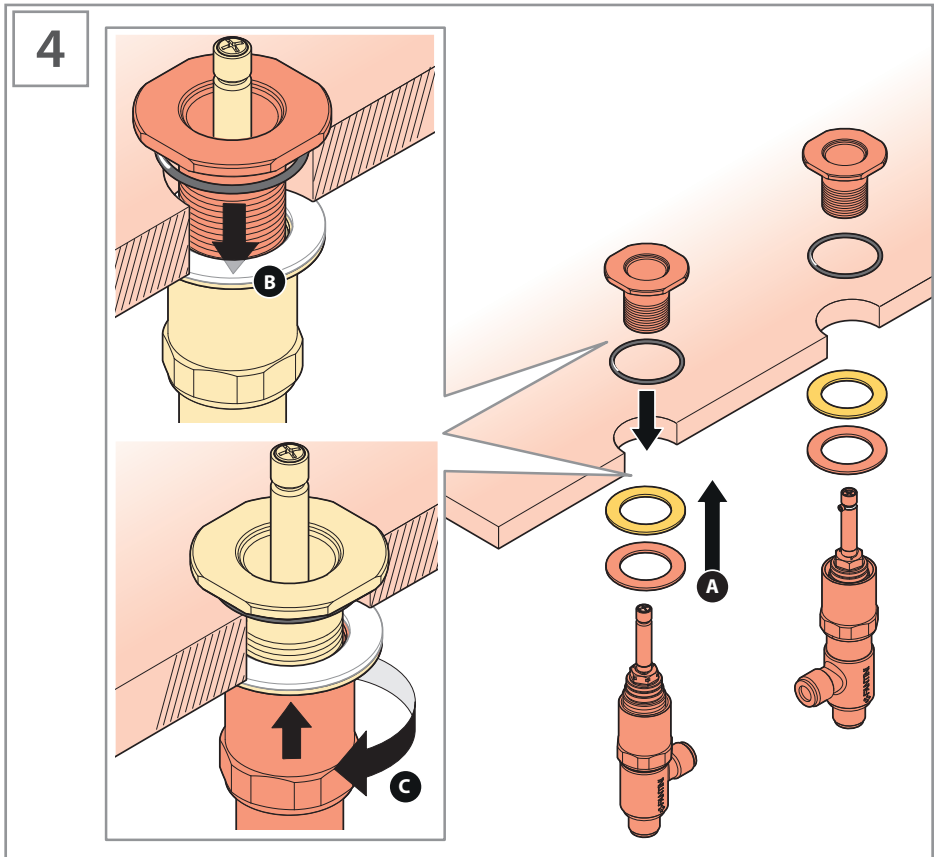
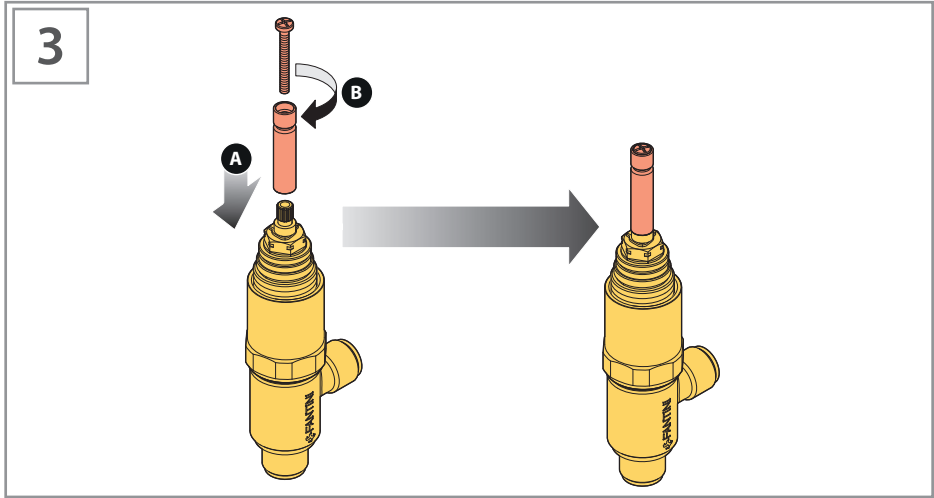

5

R065
R067

R165
R167

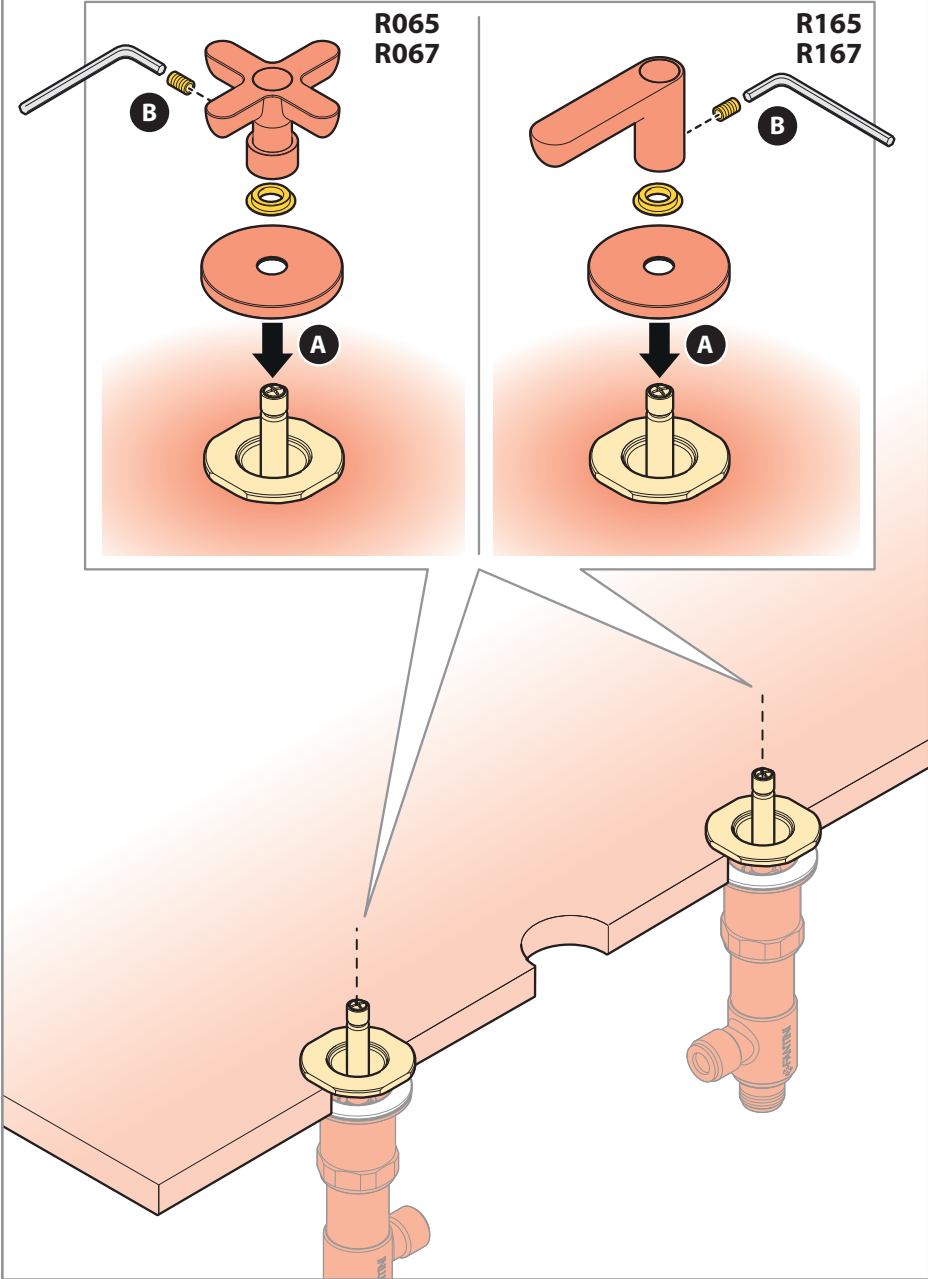

6

R065

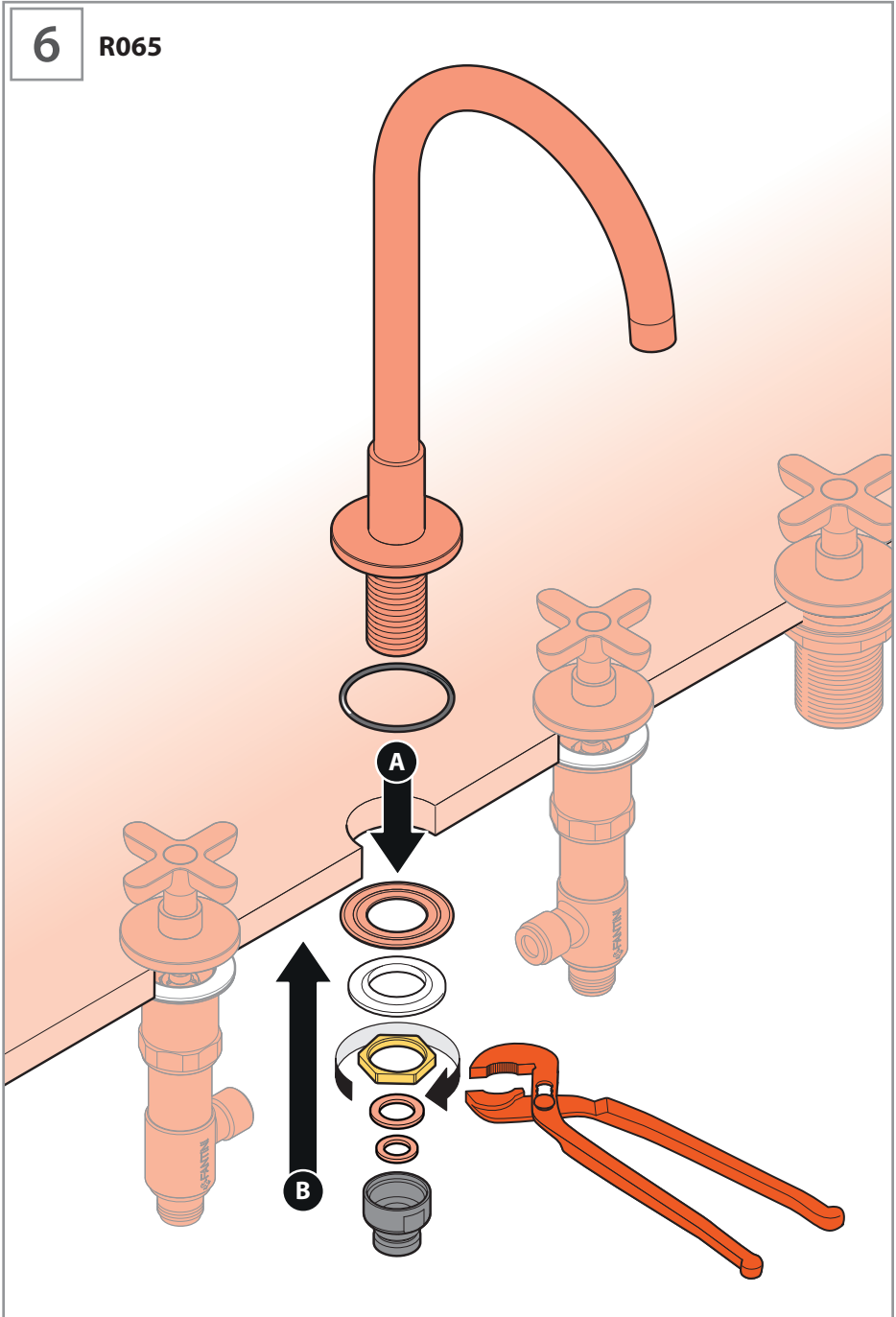

7 R165

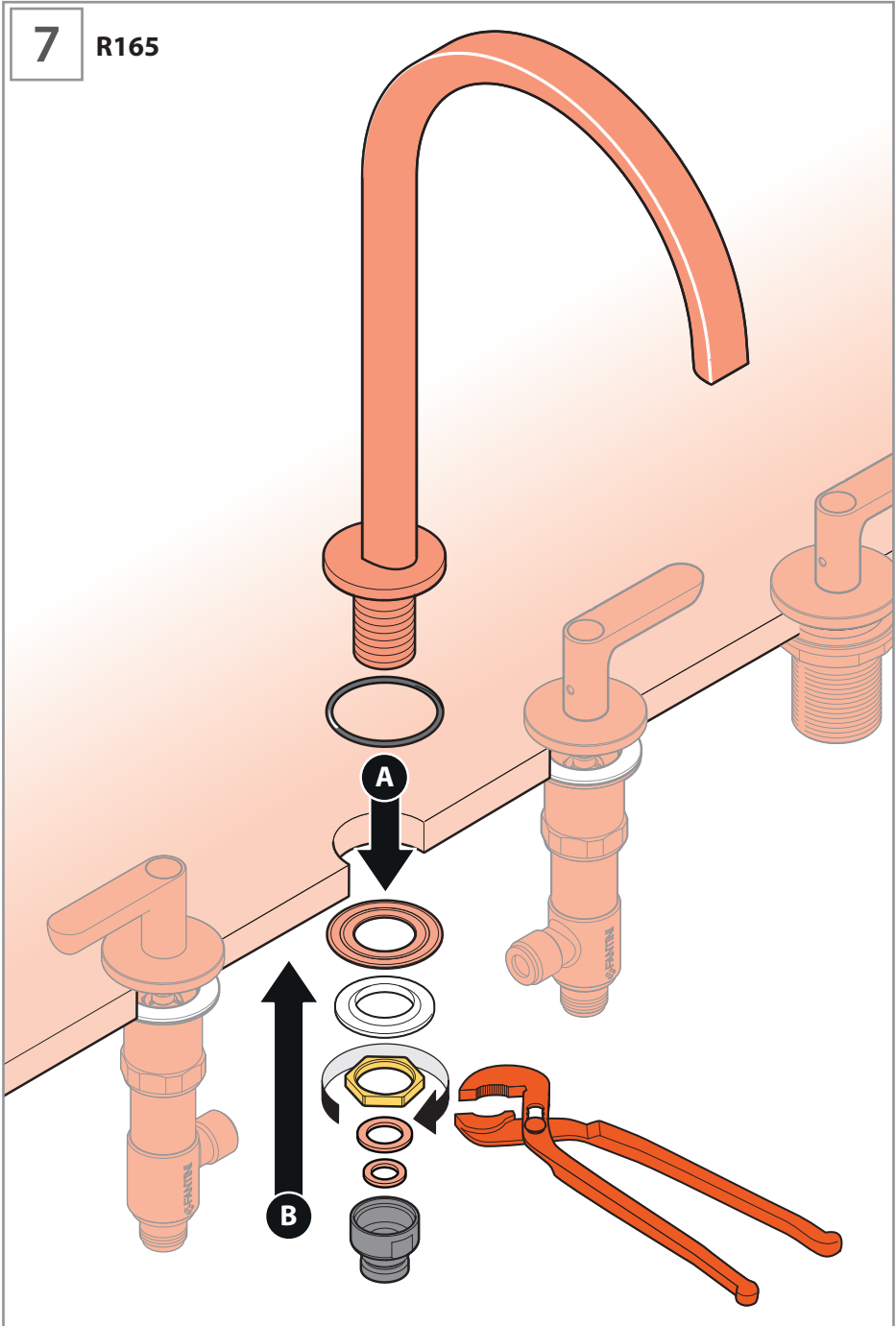
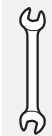

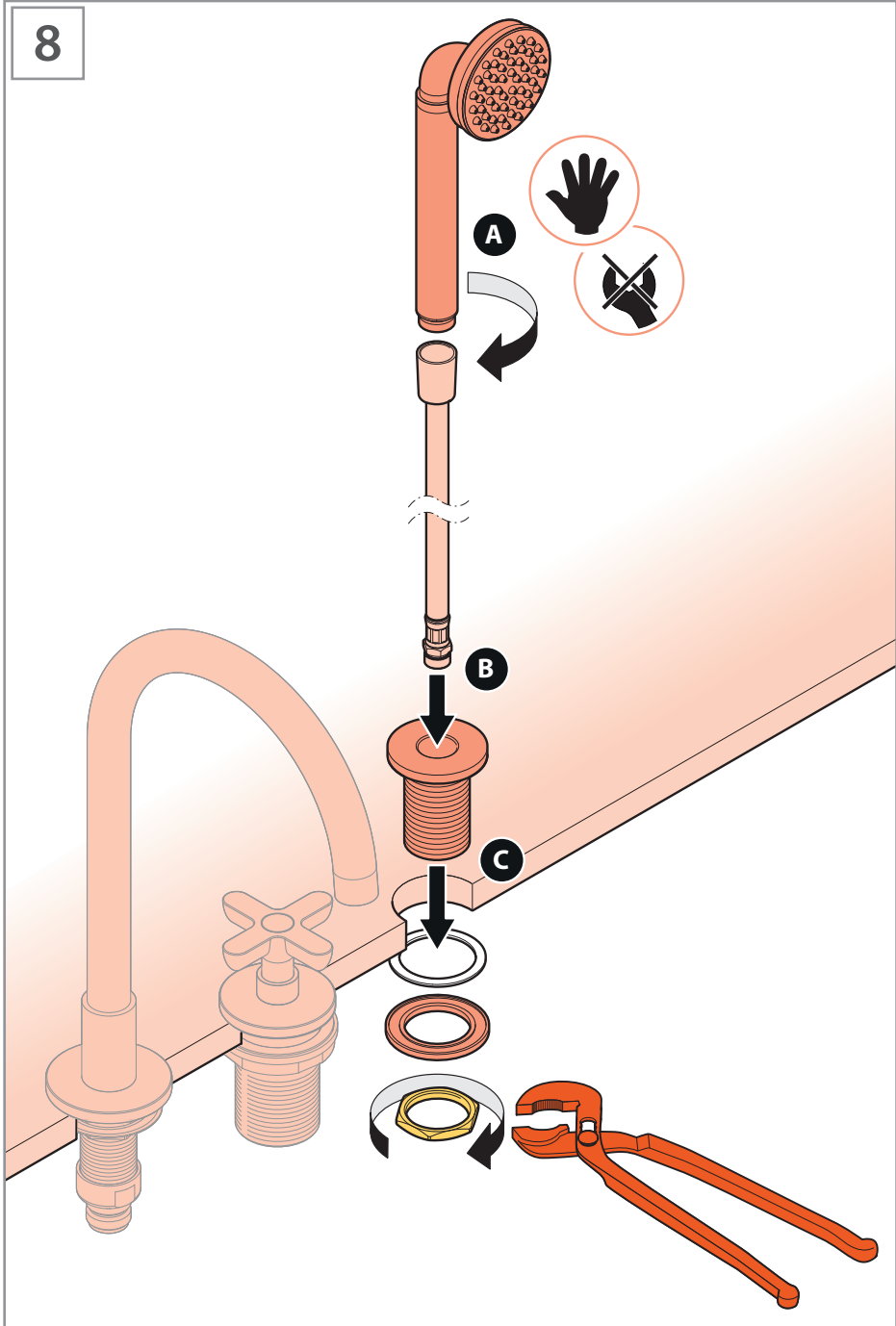

9 R065 - R165

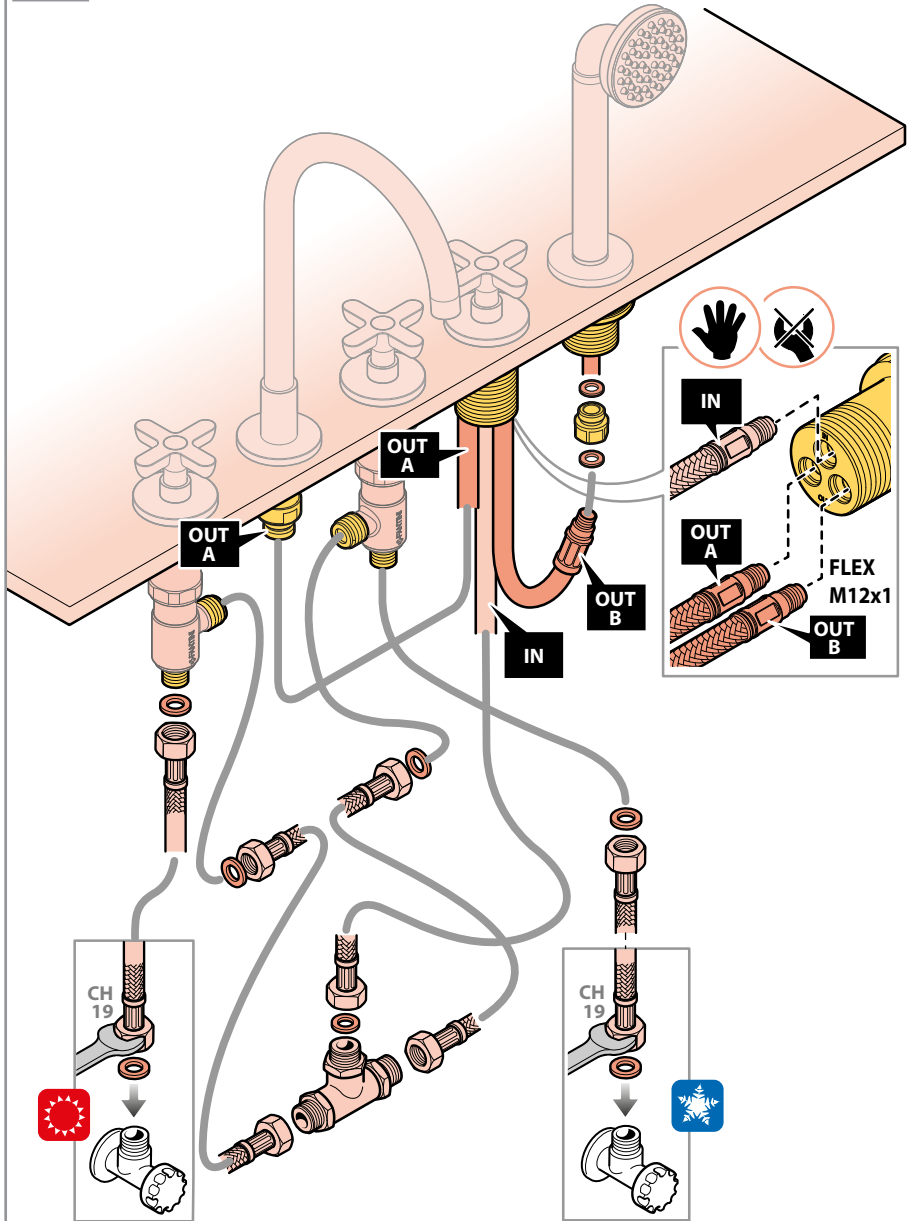

10 R067 - R167

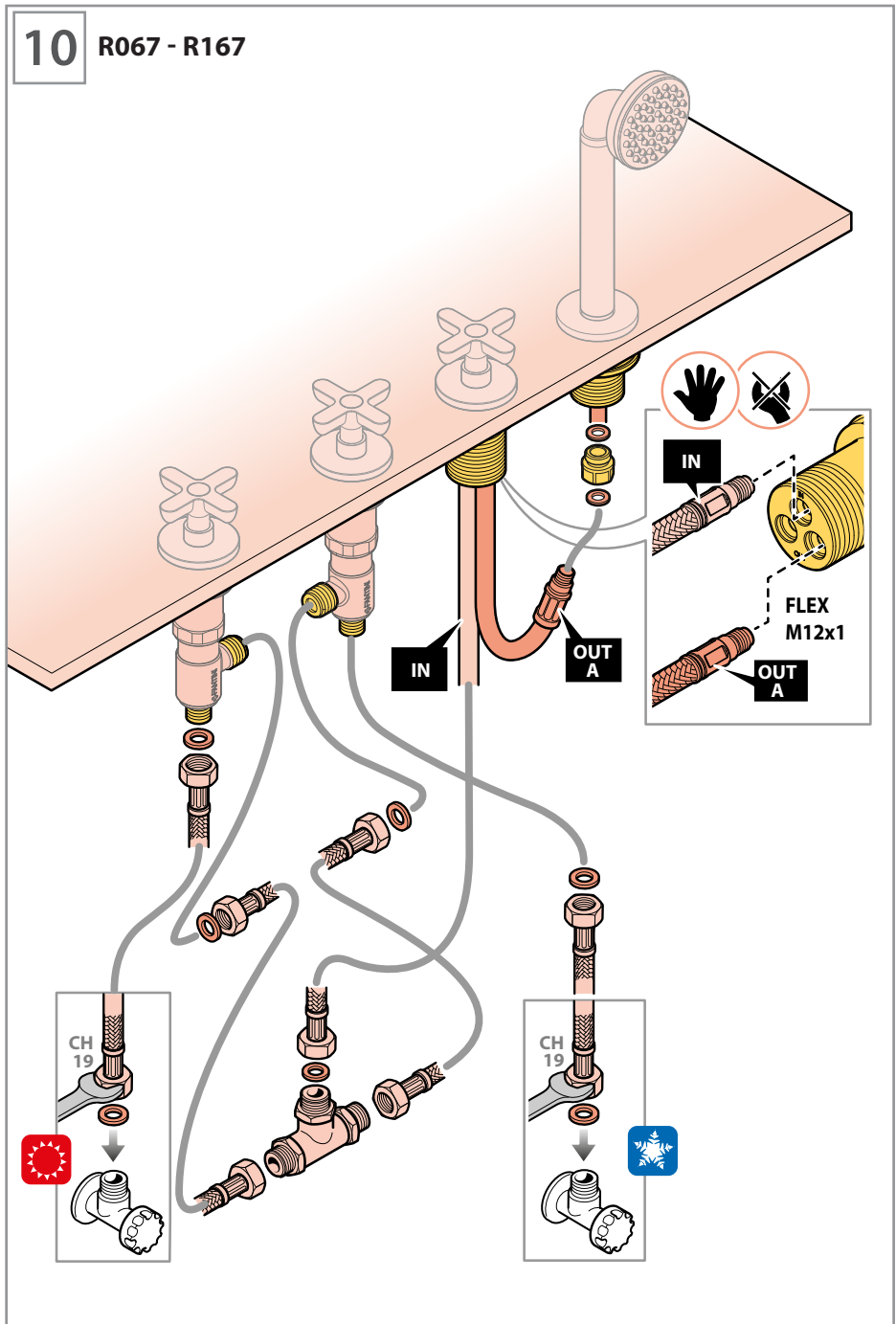

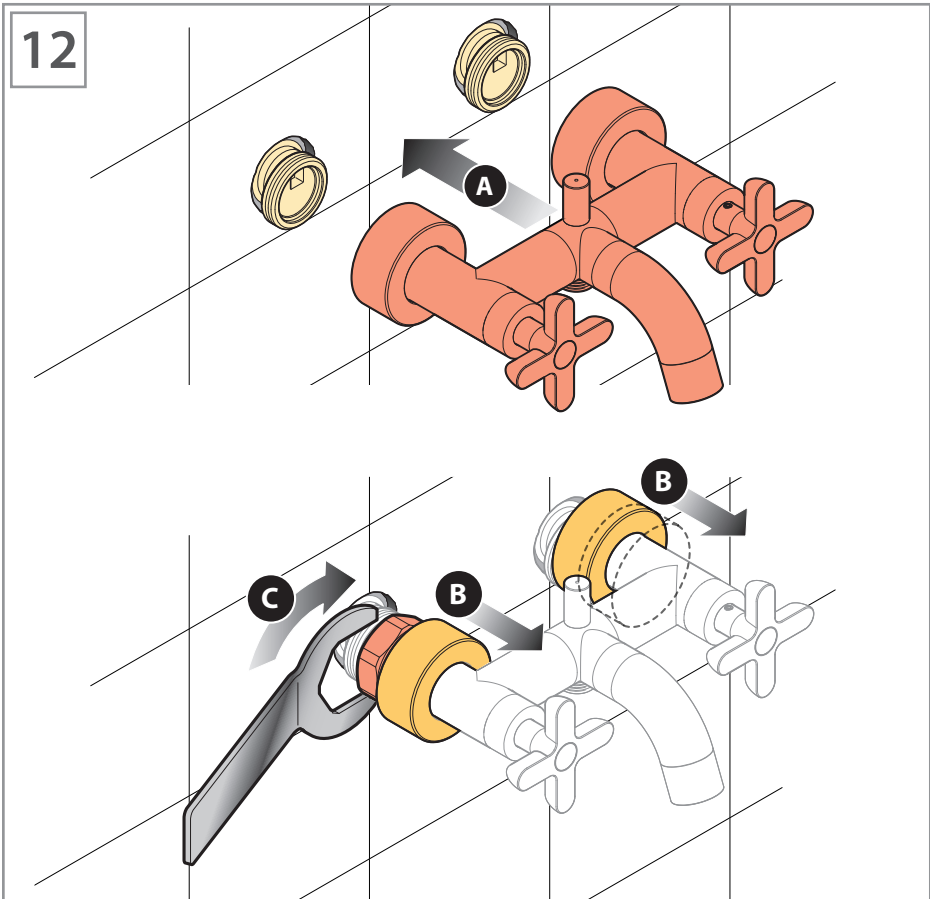
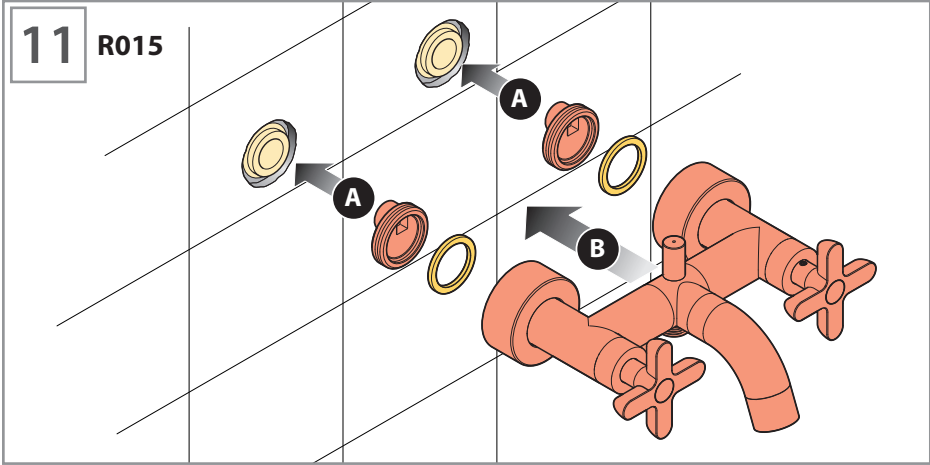

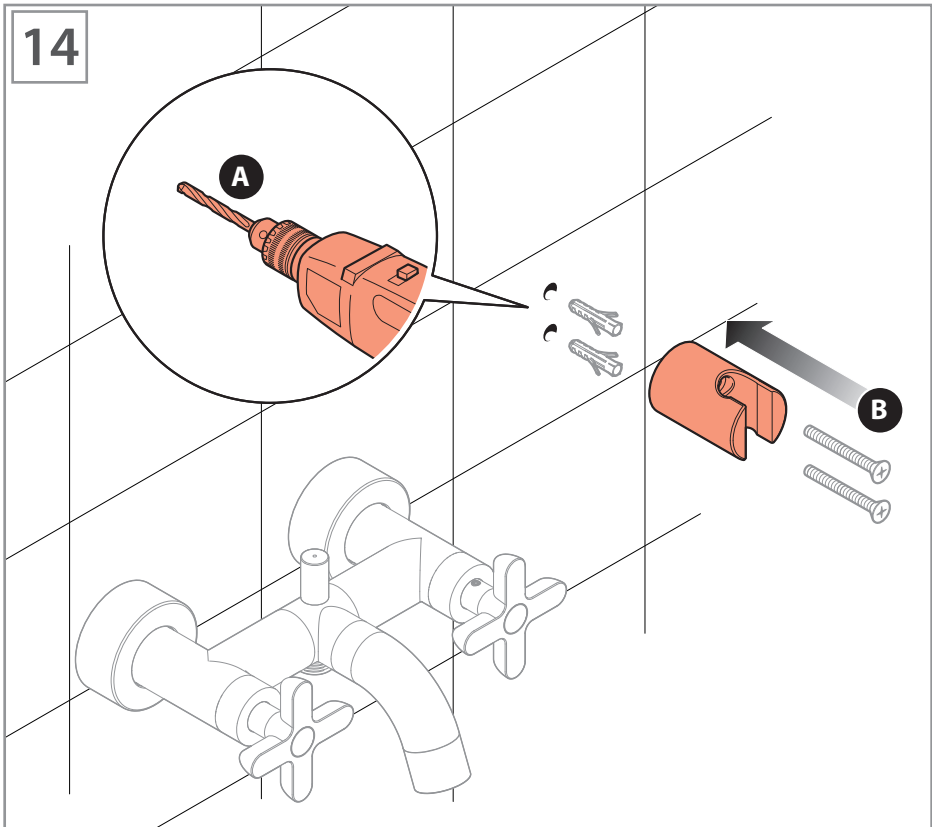
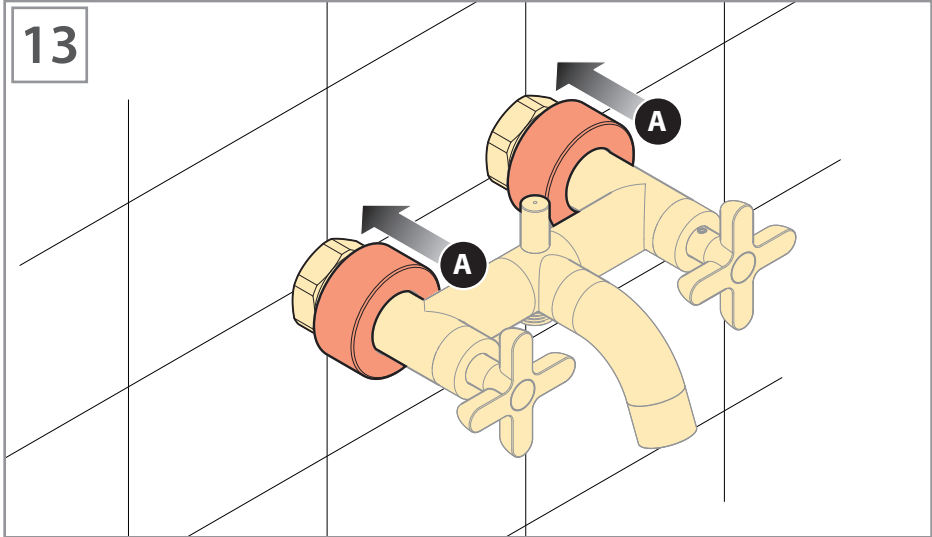

15

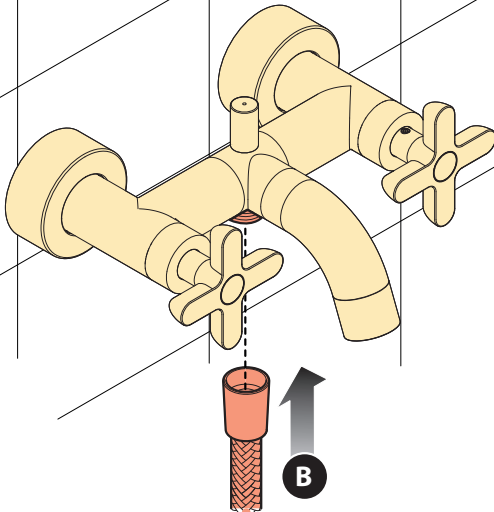
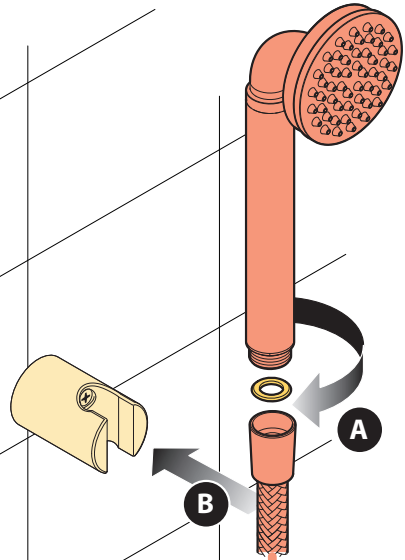
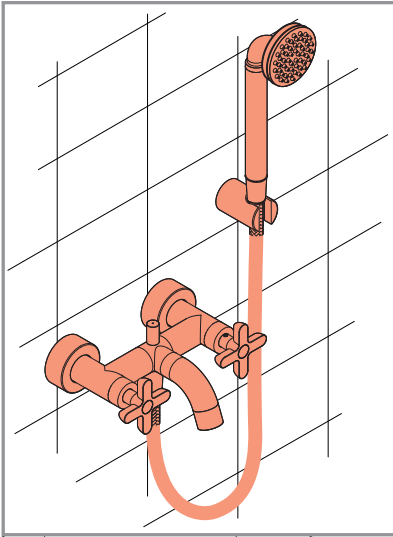

- IT** Al primo utilizzo o dopo un lungo periodo di inutilizzo, non consumare il primo mezzo litro di acqua potabile erogata. Chiudere l'impianto idraulico in caso di prolungata assenza.
Controllare periodicamente la tenuta.
- EN** On first use or following prolonged periods of inactivity, do not use the first half-litre of drinking water dispensed. Shut off the plumbing system in the event of a long absence.
Check the water-tightness regularly.
- FR** Lors de la première utilisation ou après une longue période de non utilisation, ne pas consommer le premier demi-litre d'eau potable qui sort du robinet. Fermer l'installation hydraulique en cas d'absence prolongée. Contrôler périodiquement l'étanchéité.
- DE** Schütten Sie bei Erstbenutzung oder nach einem längeren Zeitraum der Nichtbenutzung den ersten halben Liter Trinkwasser weg. Stellen Sie das Wasser bei längerer Abwesenheit ab.
Prüfen Sie in regelmäßigen Abständen die Dichtheit.
- ES** Durante el primer uso o tras un largo periodo de inactividad, no consumir el primer medio litro de agua potable que salga del grifo. Cerrar la instalación de agua si va a estar ausente durante un largo periodo. Comprobar periódicamente que no haya pérdidas
- PT** Na primeira utilização ou após um longo período de inutilização, não consuma o primeiro meio litro de água potável distribuída. Feche o circuito hidráulico no caso de ausência prolongada.
Verifique periodicamente a vedação.

IT La pulizia delle superfici va fatta utilizzando un panno morbido imbevuto con sapone liquido diluito in acqua: al termine risciacquare e asciugare con cura.

Non usare in nessun caso detersivi contenenti sostanze abrasive o a base di acido muriatico, aceto, ammoniaca, acetone, candeggina, acidi di uso domestico, disinfettanti vari o spugne abrasive.

ATTENZIONE! L'impiego di prodotti non consigliati può deteriorare irrimediabilmente le superfici, nel qual caso il produttore non risponderà del danno.

In caso di diminuzione dell'erogazione pulire o sostituire l'aeratore situato tra la doccetta ed il flessibile.

EN Clean the surfaces using a soft cloth soaked in liquid soap diluted in water, then rinse and dry thoroughly.

Never use detergents containing abrasive substances or containing muriatic acid, vinegar, ammonia, acetone, bleach, domestic acids, disinfectants in general or abrasive sponges.

CAUTION! The use of products other than those recommended may damage the surfaces irreparably, in which case the manufacturer will not be held liable.

If the flow rate decreases, clean or replace the aerator between the hand shower and the flexible hose.

FR Nettoyer les surfaces avec un chiffon doux imbibé de savon liquide dilué dans l'eau : à la fin, rincer et essuyer avec soin.

Ne jamais utiliser de détergents contenant des substances abrasives ou à base d'acide chlorhydrique, vinaigre, ammoniac, acétone, eau de javel, acides à usage domestique, désinfectants divers, ni d'éponges abrasives.

ATTENTION ! L'emploi de produits non conseillés peut détériorer irrémédiablement la surface des articles pour lesquels le fabricant ne sera pas responsable.

Au cas où la sortie d'eau diminuerait, nettoyer ou remplacer l'aérateur situé entre la douchette et le flexible.

DE Reinigen Sie die Oberfläche mit einem weichen Tuch, das in Wasser mit Flüssigseife eingetaucht wird; anschließend mit Wasser spülen und gründlich abtrocknen.

Verwenden Sie auf keinen Fall Reinigungsprodukte, die Scheuerstoffe, Salzsäure, Essig, Ammoniak, Aceton oder Bleichlauge enthalten; vermeiden Sie ebenso Säuren aus häuslicher Verwendung, Desinfektionsmittel und Scheuerschwämme.

ACHTUNG! Die Verwendung dieser nicht empfohlenen Produkte kann die Oberflächen unwiederbringlich beschädigen; der Hersteller haftet in diesem Fall nicht für Schäden.

Bei einer Verringerung des Strahls muss der zwischen Handbrause und Schlauch positionierte Strahlregler gesäubert oder ausgewechselt werden.

ES Las superficies deben limpiarse con un paño suave y jabón líquido diluido en agua: al finalizar, aclarar y secar con cuidado.

No utilizar en ningún caso detergentes que contengan sustancias abrasivas o a base de ácido clorhídrico, vinagre, amoníaco, acetona, lejía, ácidos de uso doméstico, desinfectantes varios o esponjas abrasivas.

¡ATENCIÓN! El uso de productos no recomendados puede ocasionar un deterioro irreparable de las superficies, en cuyo caso el fabricante no se responsabilizará de los daños.

Si disminuye el caudal de agua suministrado, limpiar o cambiar el aireador situado entre la ducha y el flexo.

PT A limpeza das superfícies deve ser feita utilizando um pano macio humedecido com sabão líquido diluído em água: no fim enxagúe e seque bem.

Não use, em caso algum, detergentes com substâncias abrasivas ou à base de ácido muriático, vinagre, amoníaco, acetona, lixívia, ácidos de uso doméstico, desinfetantes ou esponjas abrasivas.

ATENÇÃO! A utilização de produtos não recomendados pode danificar irremediavelmente as superfícies, nesse caso o produtor não se responsabiliza pelo dano.

Se a distribuição de água diminuir limpe ou substitua o emulsor situado entre a bica e o tubo flexível.





Fratelli Fantini SpA

via Buonarroti, 4
Pella (NO) Italia
T +39 0322 918411 r.a.
F +39 0322 969530
fantini@fantini.it

Australian Standard
Installation

Products shall be installed in accordance with AS/NZS 3500 series of standards.
Installer shall ensure that the flow controlled aerator is tightened to prevent removal by hand.

