

# Radford RAD-N-SW



 Premium



## Classic double-ended bath

- Made from QUARRYCAST®
  - One piece casting of rare volcanic limestone and resin
  - Harder & more durable than acrylic
- Easy clean high gloss finish
- Exterior can be painted
- 25 year guarantee



## Zeitlose Viktorianische doppelseitige Familienwanne

- Hergestellt aus QUARRYCAST®
  - Ein Gussteil aus seltenem vulkanischen Kalkstein und Harz
  - Härter und haltbarer als Acryl
- Leicht zu reinigende glänzende Oberfläche
- Außenseite überstreichbar
- 25 Jahre Garantie



## Baignoire classique à double assise

- Fabriquée en QUARRYCAST®
  - Ensemble d'une pièce en pierre volcanique rare et résine
  - Matériau plus dur et plus résistant que l'acrylique
- Fini ultra brillant, facile à nettoyer
- L'extérieur peut être peint
- Garantie de 25 ans



## Bañera clásica con doble espalda

- Hecho de QUARRYCAST®
  - Hecho en una pieza de piedra volcánica y resina
  - Más resistente y duradero que acrílico
- Fácil de limpiar y acabado brillante
- El exterior se puede pintar
- 25 años de garantía



## Vasca classica a doppio schienale

- Costituito da QUARRYCAST®
  - Un unico pezzo di rara roccia calcarea vulcanica e resina
  - Più robusto e resistente dell'acrilico
- Intensa finitura lucida facile da pulire
- L'esterno può essere verniciato
- 25 anni di garanzia

Recommended: **K31**



K31-PC K31-PN  
K31-PB K31-AB  
K31-BN

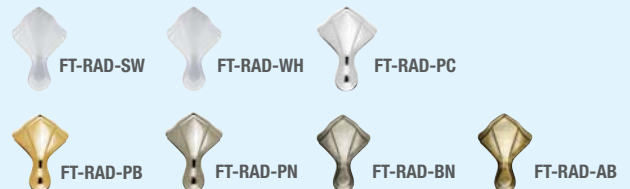

SW QUARRYCAST® white, weiß, blanc, bianco, bianco  
WH White metal, metall weiß, métal blanc, de color bianco, metallo bianco  
PC Polished chrome, Chrom poliert, Chromé, -omo metallico lucidato  
PB Polished brass, Messing poliert, Doré, Latón pulido, ottone lucidato  
PN Polished nickel, Nickel poliert, Nickel brillant, Niquel brillante, nickel lucidato  
BN Brushed nickel, Nickel gebürstet, Nickel mat, Niquel satinado, nickel spazzolato  
AB Aged bronze, Bronze antik, Bronze Vieilli, Bronze envejecido, Bronzo invecchiato



Massachusetts Code:  
File No. P1-0513-449  
cJPC listing by IAPMO:  
File No. 6574



# Radford RAD-N-SW

**Top view**

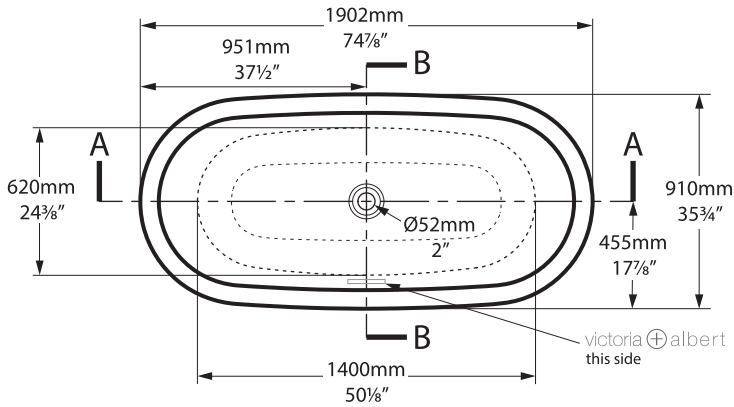

**Rim Detail**

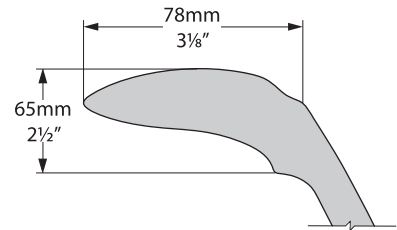

**Side view**

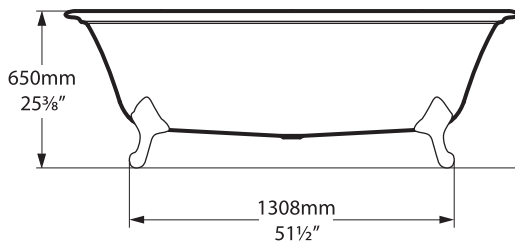

**Front view**

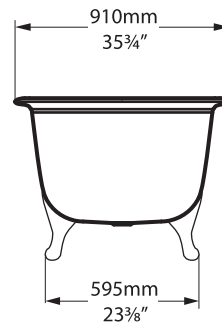

**Section BB**

Shown with K31 waste kit

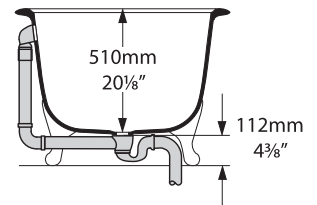

**Section AA**

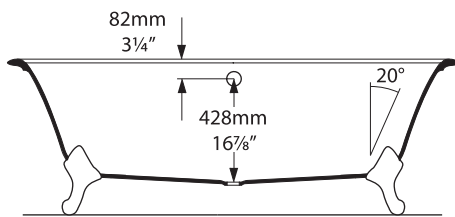

\*All measurements subject to +/-5% tolerance

