



E I C H H O L T Z

112135 WALL LAMP ECLIPS

ASSEMBLY INSTRUCTION

- 1** Turn off the electricity supply at the main circuit panel before installing. Do not connect the electricity supply until your luminaire is fully assembled and installed. Fix the wall mounting plugs to the wall.

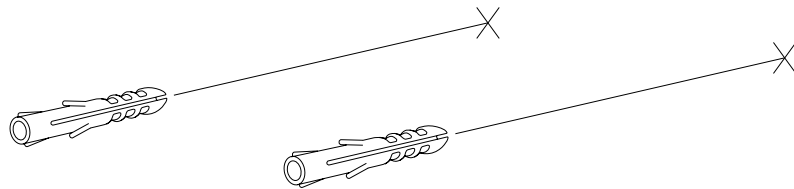

- 2** Connect the 3 wires according to their colours. Brown is the live wire, blue is the neutral wire, green/yellow is the earth wire.

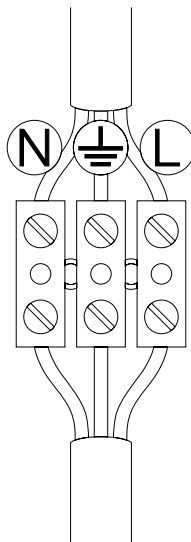

- 3** Place the lamp over the plugs and fix the lamp to the wall by using suitable screws for your wall.

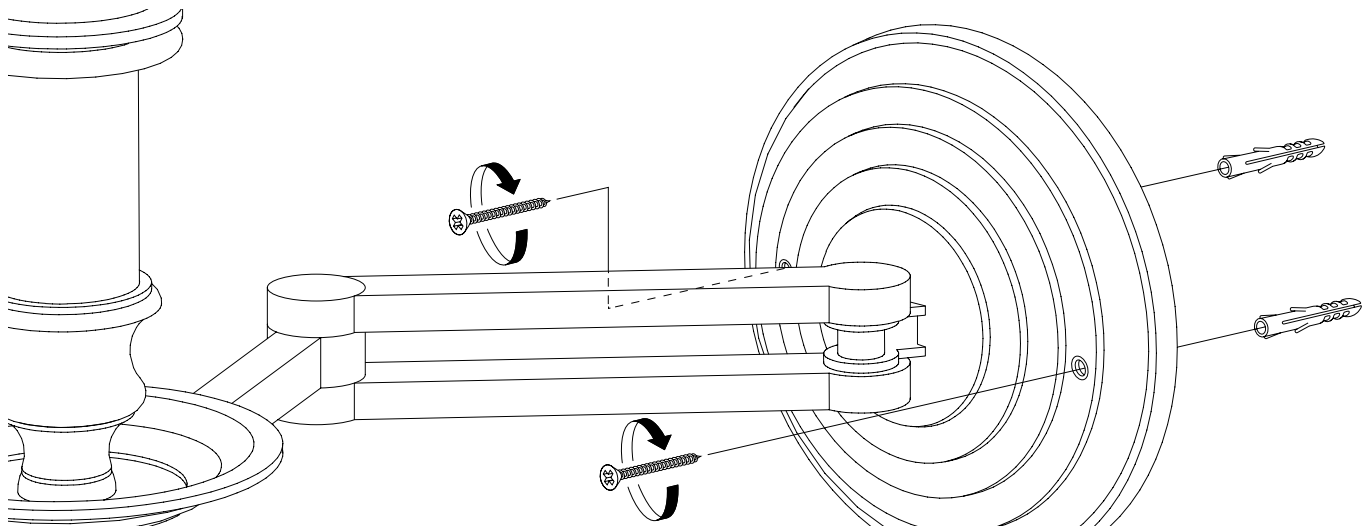



E I C H H O L T Z

108272 WALL LAMP ECLIPS

ASSEMBLY INSTRUCTION

- 4 Place the screw cover caps over the screws. Fix the shade onto the fitting using the mounting ring. Place the bulb.

