

VOLUME (l)
VOLUMEN (l)

MAX. LOAD (kg)
MAX. BELASTUNG (kg)

FLOOR LOAD (kg/m²)
BODENBELASTUNG (kg/m²)

180

335

305

- - Spot for el. cable 3x2.5mm², length approx. 1m
- - Platz Stromkabel 3 x 2,5 mm², Länge cca. 1 m
- - Spot for el. cable 1x6mm² for earthing, length approx. 1.5m
- - Platz Stromkabel 1 x 6 mm² für Erdung, Länge cca. 1,5 m



- Connection of hot and cold water 1/2" min 0.2Mpa, max 0.4Mpa
- Anschluss Warm- und Kaltwasser 1/2" min 0,2 Mpa, max 0,4 Mpa



- Drain spot Ø 50mm
- Abflussplatz Ø 50 mm



- Panel - option
- Möglichkeit - Schürze

**INSTALLATION RECOMMENDATION
MONTAGEEMPFEHLUNG**

Recommended overflow set Vorgeschlagene Überlaufgarnitur	PAL 450
Recommendations for the installation of bathtub without panel Empfehlungen für die Montage von Badewannen ohne Schürze	Nr. MK 02
Recommendations for the installation of bathtub with panel Empfehlungen für die Montage von Badewannen mit Schürze	Nr. MK 01
Option of the built-in bathtub base Möglichkeit des Sockels für die Badewannen ohne Schürze	Nr. MK 05 PKK 501
Option of the bathtub base with panel Möglichkeit des Sockels für die Badewannen mit Schürze	Nr. MK 16 CAM 150-180

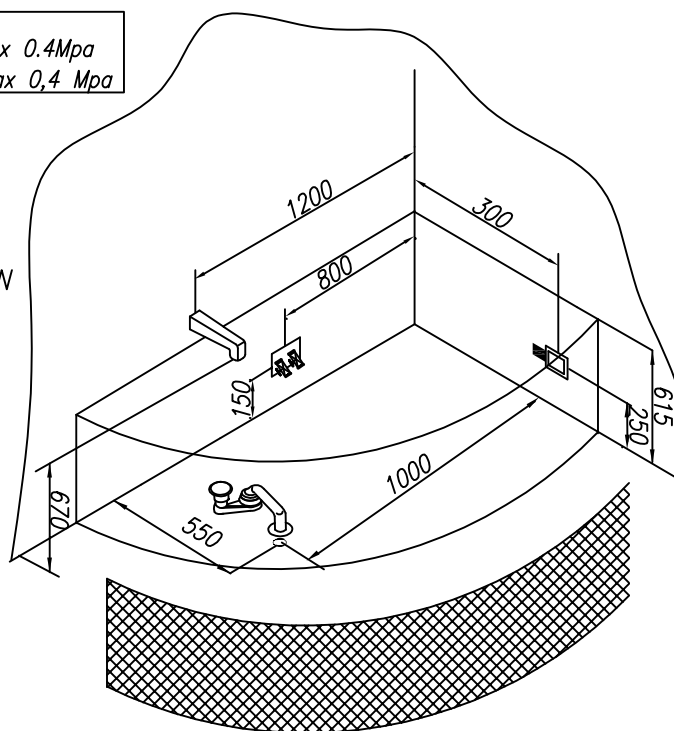

CALANDO-L 150x85

POSITION OF SWITCHES AND GENERATORS IN DIFFERENT VERSIONS OF MASSAGE SYSTEMS

POSITION SCHALTER UND AGGREGATE BEI VERSCHIEDENEN AUSFÜHRUNGEN VON MASSAGESYSTEMEN

- | | | | | |
|---|---|---|--|--|
|  - PUMP
- WASSERPUMPE |  - WATER JETS
- WASSERDÜSEN |  - AIR CONTROLLER
- LÜFTREGLER |  - ELECTRONIC SWITCHES
- ELEKTROSCHALTER |  - FIXTURE AND SHOWER HANDLE
- WASSERHAHN UND DUSCHE |
|  - BLOWER
- LUFTPUMPE |  - AIR JET
- LUFTDÜSE |  - PNEUMATIC SWITCH
- PNEUMATIKSCHALTER |  - LIGHT OR CHROMOTHERAPY
- LICHT- ODER CHROMOTHERAPIE |  - MICROJET SWITCH
- SCHALTER FÜR MIKRODÜSEN |

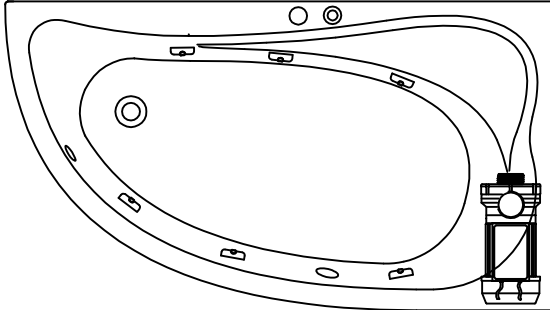

WATER MASSAGE SYSTEM 1 WASSERMASSESYSTEM 1

- | | |
|--------------------|-------------------------|
| - PUMP P=800W | - WASSERPUMPE P = 800 W |
| - PNEUMATIC SWITCH | - PNEUMATIKSCHALTER |
| - AIR CONTROLLER | - LÜFTREGLER |
| - 6 WATER JETS | - 6 WASSERDÜSEN |

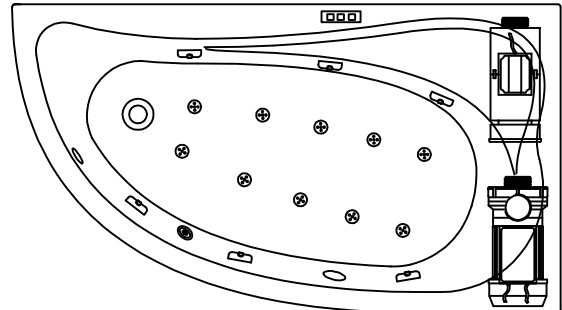

WATER AND AIR MASSAGE SYSTEM

- PUMP P=800W
- BLOWER P=800W
- ELECTRONIC SWITCH
- 6 SUPER WATER JETS
- 10 AIR JETS
- AIR REGULATOR

WASSER UND LUFT MASSAGESYSTEM

- WASSERPUMPE P = 800 W
- LUFTPUMPE P = 800 W
- ELEKTROSCHALTER
- 6 SUPER-WASSERDÜSEN
- 10 LUFTDÜSEN
- LÜFTREGLER

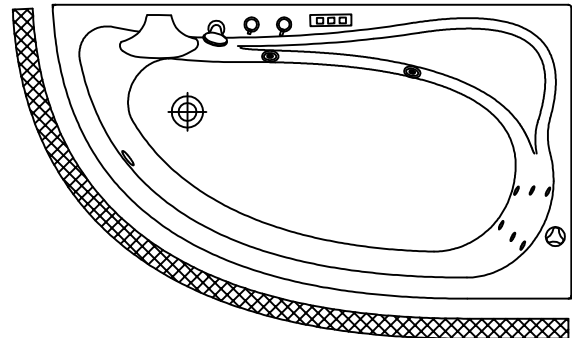

- OPTION FIXTURE AND SHOWER HANDLE - MÖGLICHKEIT WASSERHAHN UND DUSCHE

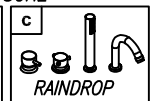
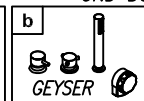
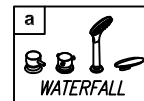
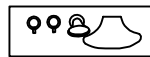

- OPTION 6 MICROJETS P=1250W

- MÖGLICHKEIT MIKRODÜSEN 6 P = 1250 W



- OPTION CHROMOTHERAPY

- MÖGLICHKEIT CHROMOTHERAPIE



- OPTION PANEL FOR BATHTUB

- OPTION SHÜRZE FÜR BADEWANNE

