



I **ATTENZIONE: LA SICUREZZA DELL'APPARECCHIO E' GARANTITA SOLO CON L'USI APPROPRIATO DELLE SEGUENTI ISTRUZIONI. CONSERVARLE CON CURA.**

Prima di eseguire qualsiasi tipo di operazione togliere la tensione di rete
Per la pulizia dei vetri si raccomanda di non usare mai abrasivi o solventi
Fare attenzione a non superare il Max di watt indicati per l'apparecchio
L'apparecchio non può essere usato in ambienti umidi o all'esterno
Mai coprire l'apparecchio durante l'impiego.

Max. potenza lampada **36W**
Attacco lampada **LED 3000K**
Tipo lampada 
Apparecchio classe I
Grado di protezione **IP20**

GB **ATTENTION: THE SAFETY OF THE APPLIANCE IS GUARANTEED ONLY IF IT IS PROPERLY USED, ACCORDING TO THE FOLLOWING INSTRUCTIONS, WHICH ARE TO BE KEPT.**

Always disconnect the power supply before installing or performing any maintenance operations
For cleaning the glass do not use any abrasive or solvent materials
Make attention of not exceeding the maximum watt indicated on the appliance
The appliance may not be used in humid or external environments
Never cover the appliance while in function

Capacity of bulb **36W**
Type of lampholder **LED 3000K**
Type of bulb 
Appliance in class I
Protection class **IP20**

D **ACHTUNG: DIE SICHERHEIT DIESES BELEUCHTUNGSKÖRPERS WIRD NUR DURCH DIE KORREKTE ANWENDUNG DER NACHSTEHENDEN ANWEISUNGEN GEWÄHRLEISTET. DIESE ÜSSEN DAHER SORGFÄLTIG AUFBEWAHRT WERDEN.**

Bevor irgendwelche Arbeitsgänge ausgeführt werden, muß die Stromversorgung unterbrochen
Zur Reinigung der Gläser dürfen keine Scheuer- bzw. Lösungsmittel verwendet werden
Achten Sie darauf, daß die auf dem Beleuchtungskörper angegebene maximale Wattzahl nicht überschritten wird
Der Beleuchtungskörper darf nicht in feuchten Räumen bzw. im Freien eingesetzt werden
Den Beleuchtungskörper während dem Betrieb nicht abdecken

Leistung der Gluehbirne **36W**
Anschluss **LED 3000K**
Typ der Gluehbirne 
Gerät der Klasse I
Schutzklasse **IP20**

RU **ВНИМАНИЕ: БЕЗОПАСНОСТЬ ОСВЕТИТЕЛЬНОГО ПРИБОРА ГАРАНТИРОВАНА ТОЛЬКО ПРИ УСЛОВИИ ЕГО ЭКСПЛУАТАЦИИ В СООТВЕТСТВИИ С ПРИВЕДЕННЫМИ НИЖЕ ИНСТРУКЦИЯМИ, КОТОРЫЕ НЕОБХОДИМО СОХРАНИТЬ.**

Перед выполнением любой операции с осветительным прибором отключить напряжение в сети
Рекомендуется никогда не чистить стекло при употреблении абразивных веществ или Растворителей
Не превышать максимально допустимую мощность, указанную для данного осветительного прибора
Осветительный прибор не может быть использован во влажных помещениях или на улице
Никогда не накрывать осветительный прибор в рабочем режиме

Максимальная мощность лампочки **36W**
Тип цоколя лампочки **LED 3000K**
Тип лампочки 
Осветительный прибор КЛАССА I
Класс защиты **IP20**

F **ATTENTION: LA SÉCURITÉ DE CET APPAREIL N'EST GARANTIE QUE SI L'ON RESPECTE LES INSTRUCTIONS SUIVANTES. IL EST, PAR CONSÉQUENT, INDISPENSABLE DE LES CONSERVER SOIGNEUSEMENT.**

Avant d'effectuer toute opération, débrancher la tension de réseau
Ne jamais utiliser des abrasifs ou des solvants pour le nettoyage des parties en verre
Veiller à ne pas dépasser la limite maximale des watts indiquée sur l'appareil
Cet appareil ne peut pas être utilisé dans des pièces humides ni à l'extérieur
Ne jamais couvrir l'appareil pendant son fonctionnement

Puissance ampoule **36W**
Culot **LED 3000K**
Type ampoule 
Appareil de classe I
Classe de protection **IP20**

P **ATENÇÃO: A SEGURANÇA DO APARELHO É GARANTIDA SOMENTE SE FOREM RESPEITADAS AS INSTRUÇÕES. PORTANTO, É NECESSÁRIO CONSERVÁ-LAS.**

Antes de fazer qualquer tipo de operação, desligar a corrente eléctrica da rede
Para limpeza do vidro não usar materiais abrasivos ou solventes
Prestar atenção para não superar o número de watts indicados para o aparelho
O aparelho não pode ser utilizado em ambientes húmidos ou no exterior
Nunca cobrir o aparelho durante o funcionamento

Potência máxima da lâmpada **36W**
Tipo de suporte da lâmpada **LED 3000K**
Tipo de lâmpada 
Aparelho de CLASSE I
Classe de protecção **IP20**

E **ATENCIÓN: LA SEGURIDAD DEL APARATO ESTÁ GARANTIZADA SÓLO POR UN USO ADECUADO DE LAS SIGUIENTES INSTRUCCIONES; POR CONSIGUIENTE, ES PRECISO CONSERVARLAS.**

Antes de llevar a cabo cualquier tipo de operación, desconectar la tensión de la red
Para limpiar el cristal no utilize ningún abrasivo o solvente
Prestar atención a no superar el máximo de los vatios indicados en el aparato
El aparato no podrá utilizarse en ambientes húmedos ni en exteriores
No cubrir jamás el aparato durante el funcionamiento

Potencia máxima de la bombilla **36W**
Casquillo de la bombilla **LED 3000K**
Tipo de bombilla 
Aparato CLASE I
Clase de protección **IP20**

⚠ Per composizioni di più lampade staccare la linguetta e far passare i cavi attraverso il foro
 For compositions of several lamps break off the tab and make route the cables through the hole

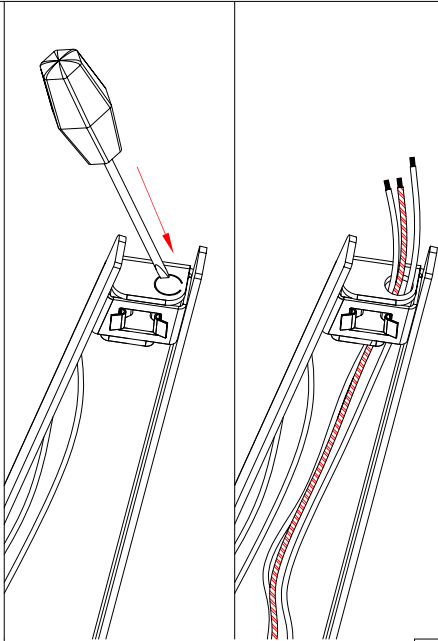

- ① - Procedere al montaggio seguendo le operazioni in ordine numerico progressivo.
- ② - Proceed with assembly following the operations in progressive numerical order.
- ③ - Arbeitsgänge in numerischer Ordnung ausführen, um das Gerät zu installieren.
- ④ - Производите установку в порядке увеличения обозначенных выше номеров.
- ⑤ - Il faut procéder à le montage exécutant les opérations par l'ordre numérique progressif.
- ⑥ - Proceder a montaje seguindo as istruçoes em ordem numerica progressiva.
- ⑦ - Proceder al montaje seguindo las operaciones en orden numerico progresivo.

Esempi di composizioni
 Examples of compositions

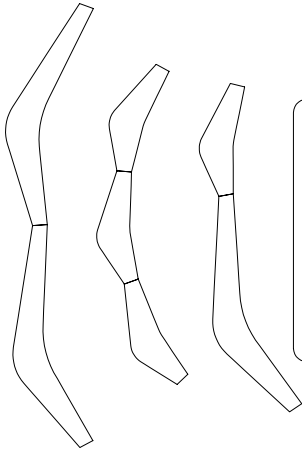

⚠ Usare la dritta di cartone per segnare i punti di foratura a parete
 Use the cardboard template to mark the drilling points on the wall

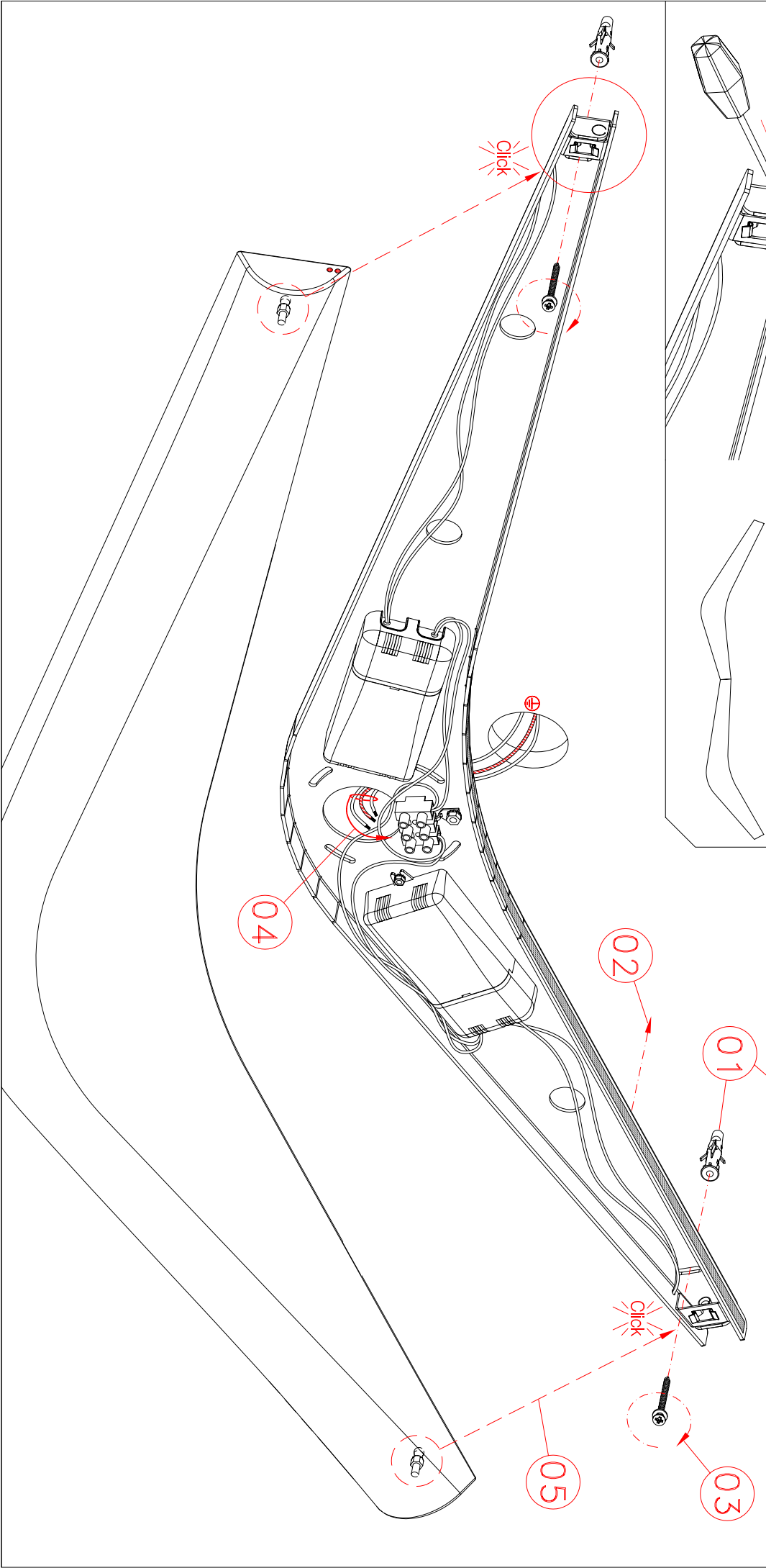
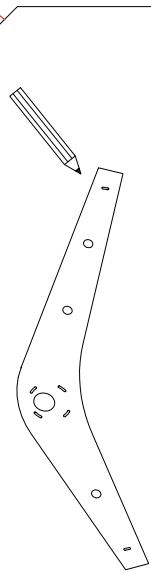

Fabbian

F29 D01 - F29 D03

MINI JOLLY 20 - 1...10 V & PUSH

Direct current dimmable electronic drivers multivoltage-multicurrent
Alimentatori elettronici multicorrente-multitensione regolabili in corrente continua

Made in Europe



DC MINI JOLLY



DC MINI JOLLY BI



LED
LED

Rated Voltage Tensione Nominale

110 ÷ 127 V⁽²⁾
220 ÷ 240 V

Frequency Frequenza

50...60 Hz

AC Operation range Tensione di utilizzo AC

99 ÷ 264 V

DC Operation range Tensione di utilizzo DC

170 ÷ 280 V
(NO PUSH mode function)

Power

0 ÷ 20 W

Maximum current output ripple Max. ondulazione della corrente uscita

≤ 3%⁽¹⁾

Reference Norms

Norme di riferimento:

EN 50172 (VDE 0108)
EN 55015
EN 61000-3-2
EN 61000-3-3
EN 61347-1
EN 61347-2-13
EN 61547
EN 62384
VDE 0710-T14

Article Articolo	Code Codice	P out W	V out DC	I out DC	n° LED max. ⁽¹⁾	V out max.	ta °C	tc °C	λ max. Power Factor	η max. Efficiency ⁽¹⁾
DC MINI JOLLY	122400	Constant current output - Uscita in corrente costante					-25... +50	80 ⁽³⁾	0,95	> 87
DC MINI JOLLY BI⁽²⁾	122404	15 (15 ⁽²⁾)	43 max.	350 mA cost.	12	49				
		20 (15 ⁽²⁾)	43 max.	500 mA cost.	9/10					
		20 (15 ⁽²⁾)	43 max.	550 mA cost.	9/10					
		20 (15 ⁽²⁾)	36 max.	700 mA cost.	6/7					
		20 (15 ⁽²⁾)	24 max.	850 mA cost.	5/6					
		20 (15 ⁽²⁾)	22 max.	900 mA cost.	4/5					
		Constant voltage output - Uscita in tensione costante								
		9 (9 ⁽²⁾)	10 cost.	900 mA max.	-	-				
		10 (10 ⁽²⁾)	12 cost.	900 mA max.	-	-				
		20 (15 ⁽²⁾)	24 cost.	900 mA max.	-	-				

⁽¹⁾ Referred to V_m = 230 V, 100% load - Riferito a V_m = 230 V, carico 100%

⁽³⁾ Tc = 75°C for Pout ≤ 16W

Accessories not supplied - Accessori non a corredo

Article - Articolo	Code - Codice
CP 1-10 V (pag. 269)	123999L

Features

- Multi-power driver supplied with dip-switch for the selection of the output current.
- IP20 independent driver, for indoor use (DC MINI JOLLY).
- Class II protection against electric shock for direct or indirect contact (DC MINI JOLLY).
- Driver for built-in use (DC MINI JOLLY BI).
- It can be used for lighting equipment in protection class I and II (DC MINI JOLLY BI).
- Active Power Factor Corrector.
- Current regulation ±5 % including temperature variations.
- Input and output terminal blocks on the same side (wire cross-section up to 1,5 mm²).
- Clamping screws on primary and secondary circuits for cables with diameter: min. 3 mm - max. 8 mm (DC MINI JOLLY).
- Protections:
 - against overheating and short circuits;
 - against mains voltage spikes;
 - against overloads.
- Thermal protection = C.5.a.
- Can be switched on and off on secondary circuit for power LED (for additional details page info15).
- Double output impedance for use in household electrical appliances.

Caratteristiche

- Alimentatore multipotenza fornito di dip-switch per la selezione della corrente in uscita.
- Alimentatore indipendente IP20, per uso interno (DC MINI JOLLY).
- Protetto in classe II contro le scosse elettriche per contatti diretti e indiretti (DC MINI JOLLY).
- Alimentatore da incorporare (DC MINI JOLLY BI).
- Utilizzabile per apparecchi di illuminazione in classe di protezione I e II (DC MINI JOLLY BI).
- PFC attivo.
- Corrente regolata ±5 % incluse variazioni di temperatura.
- Morsetti di entrata e uscita sullo stesso lato (sezione cavo fino a 1,5 mm²).
- Serracavo su primario e secondario per cavi di diametro: min. 3 mm - max. 8 mm (DC MINI JOLLY).
- Protezioni:
 - termica e cortocircuito;
 - contro le extra-tensioni di rete;
 - contro i sovraccarichi.
- Protezione termica = C.5.a.
- Possibilità di accensione e spegnimento sul secondario per LED alimentati in corrente (per ulteriori dettagli pagina info15).
- Doppia impedenza d'uscita per l'utilizzo in apparecchi elettrodomestici.



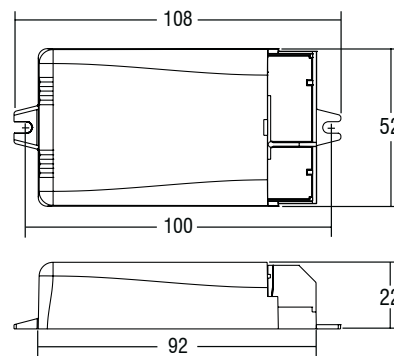
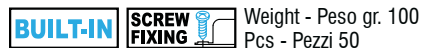
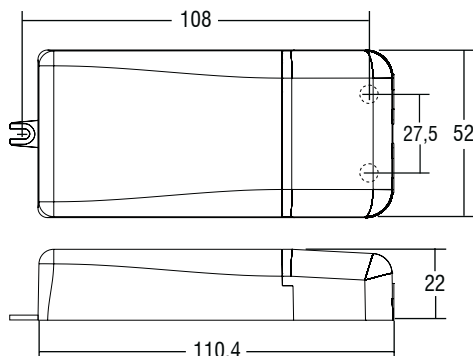
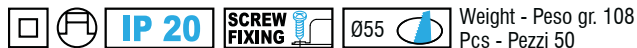

Wiring diagram - Schema di collegamento (Max. LED distance on page info8 - Massima distanza LED a pagina info8)

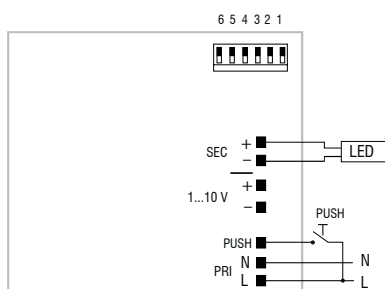

PUSH diagram - Collegamento PUSH

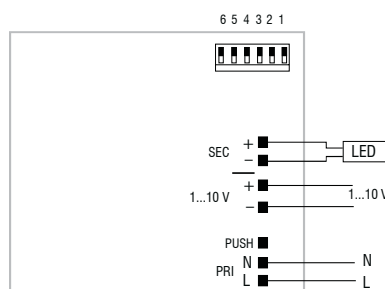

1...10 V diagram - Collegamento 1...10 V



Operation Mode

- Light regulation 0/0,5 - 100 % by means of PUSH function, 1...10 V interface (I=0,35 mA) or 100 Kohm potentiometer.
- Light regulation 0/0,5 - 100 % by means of PUSH function (L mains voltage: 170 Kohm):
 - a short push to turn on and off;
 - a longer push to increase or decrease light intensity;
 - regulation automatically stops at minimum and maximum values;
 - for another on, regulation or off command, release the push button and give the desired command again.
- Maximum length of the cable, from push button to last driver, must be max. 15 m. In case of applications where the cable is longer than 15 m, keep this separate from the 110 - 240 Volt mains cable.
- ATTENTION: only use normally open push buttons with no incorporated warning light.
- Specific dimming terminal connection with a 1...10 Vdc electronic potentiometer (1...10 V local dimming, double insulation required for external connection).

For additional details for regulations see pages info12-14.

Modalità di funzionamento

- Regolazione della luminosità 0/0,5 - 100 % mediante funzione PUSH, Interfaccia 1...10 V (I=0,35 mA) o potenziometro da 100 Kohm.
 - Regolazione della luminosità 0/0,5 - 100 % mediante la funzione PUSH (tensione di rete L; 170 Kohm):
 - una pressione breve per accendere e spegnere;
 - una pressione prolungata per aumentare o diminuire l'intensità luminosa;
 - la regolazione si ferma automaticamente ai valori minimi e massimi;
 - per un nuovo comando accensione, regolazione o spegnimento, rilasciare il pulsante e dare nuovamente il comando desiderato.
 - La lunghezza massima del cavo, dal pulsante all'ultimo trasformatore, deve essere max. 15 m. In caso di applicazioni dove il cavo superi i 15 m, tenere lo stesso separato dal cavo di rete 110 - 240 Volt.
 - ATTENZIONE: usare solo pulsanti di tipo normalmente aperto privi di spia luminosa incorporata.
 - Provvisto di morsetto specifico per la regolazione collegando un potenziometro elettronico 1...10 Vdc (dimmerazione locale 1...10 V, per connessioni esterne all'apparecchio garantire il doppio isolamento).
- Per ulteriori dettagli sulle regolazioni vedi pagine info12-14.