

ELIKA TONDO

G. Carollo

2011



porada

ELIKA TONDO

G. Carollo

2011

Tavolo da pranzo con base centrale in massello di noce canaletta o frassino montata su una piastra in metallo e piano in cristallo temperato (spessore mm.12).

Dining-table with base in solid canaletta walnut or ash fixed on a metal ring and tempered glass top (thickness mm. 12).

Ess-Tisch mit Gestell aus massivem Nussbaum Canaletta oder Esche auf eine Metallplatte und ESG-Glasplatte (Stärke mm. 12).

Table à manger avec piètement en noyer canaletta ou frêne massif fixé sur une plaque en métal et plateau en verre trempé (épaisseur mm. 12).

Mesa de comedor con base de nogal canaletta o fresno macizo montada sobre de un disco de metal y tapa en cristal templado (espesor mm. 12).

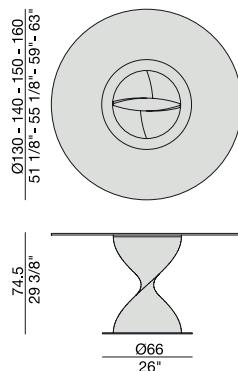

ESSENZE | *Essences*



Noce Canaletta
Canaletta Walnut

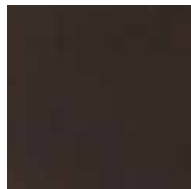

Noce Canaletta
Canaletta Walnut
tinto/stained moka



Noce Canaletta
Canaletta Walnut
tinto/stained wengé



Frassino Naturale
Natural Ash

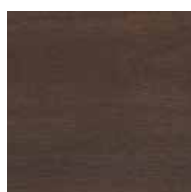

Frassino
Ash
tinto/stained moka

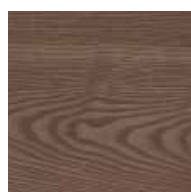

Frassino
Ash
tinto noce canaletta
canaletta walnut stained

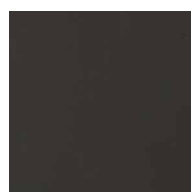

Frassino
Ash
tinto/stained wengé



Frassino
Ash
tinto/stained canapa

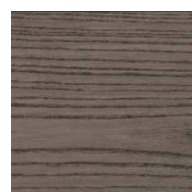

Frassino
Ash
tinto/stained caffè

LACCATO OPACO PORO CHIUSO | *Matt lacquered closed pore*

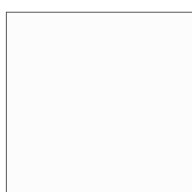

Bianco
White
(RAL 9016)



Avorio
Ivory
(RAL 1013)



Argilla
Mud
(RAL 7006)



Piombo
Lead
(NCS S5005G20Y)



Cioccolato
Chocolate
(RAL 8019)

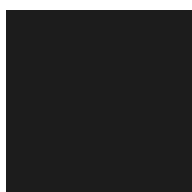

Nero
Black
(RAL 9005)



Granata
Garnet red
(NCS S4050Y90R)



Pistacchio
Pistachio green
(PANTONE 5825)



Avio
Aviation blue
(PANTONE 5415)

LACCATO OPACO PORO APERTO | *Matt lacquered open pore*

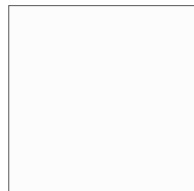

Bianco
White
(RAL 9016)

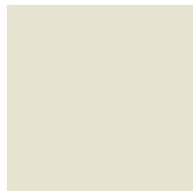

Avorio
Ivory
(RAL 1013)



Argilla
Mud
(RAL 7006)



Piombo
Lead
(NCS S5005G20Y)



Cioccolato
Chocolate
(RAL 8019)

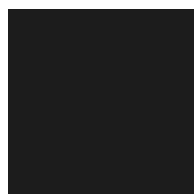

Nero
Black
(RAL 9005)



Granata
Garnet red
(NCS S4050Y90R)



Pistacchio
Pistachio green
(PANTONE 5825)



Avio
Aviation blue
(PANTONE 5415)

CRISTALLO | *Glass*

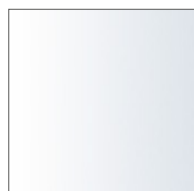

Trasparente
Transparent

METALLO | *Metal*

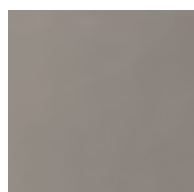

Cromo satinato
Satin chromed

ELIKA TONDO BRILLANTE

G. Carollo

2011

Tavolo da pranzo con base centrale in tecnopolimero strutturale montata su una piastra in metallo e piano in cristallo temperato (spessore mm. 12).

Dining-table with base in structural technopolymer fixed on a metal ring and tempered glass top (thickness mm. 12).

Ess-Tisch mit Gestell aus Strukturel Technopolymer auf eine Metallplatte und ESG-Glasplatte (Stärke mm. 12).

Table à manger avec piétement en technopolymère structural fixé sur une plaque en métal et plateau en verre trempé (épaisseur mm. 12).

Mesa de comedor con base de tecnopolímero montada sobre de un disco de metal y tapa en cristal templado (espesor mm. 12).

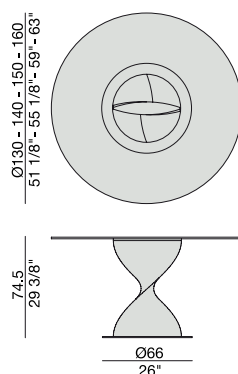

ELIKA TONDO BRILLANTE

G. Carollo

2011

TECNOPOLIMERO | *Technopolymer*

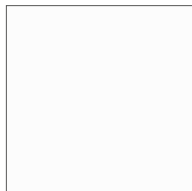

Bianco brillante
Shiny White

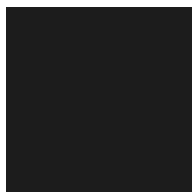

Nero brillante
Shiny Black

CRISTALLO | *Glass*

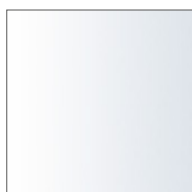

Trasparente
Transparent

METALLO | *Metal*

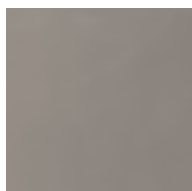

Cromo satinato
Satin chromed

ELIKA 180

G. Carollo

2011



ELIKA 180

G. Carollo

2011

Tavolo da pranzo con base centrale in massello di noce canaletta o frassino montata su una piastra in metallo e piano in cristallo temperato (spessore mm.12).

Dining-table with base in solid canaletta walnut or ash fixed on a metal ring and tempered glass top (thickness mm. 12).

Ess-Tisch mit Gestell aus massivem Nussbaum Canaletta oder Esche auf eine Metallplatte und ESG-Glasplatte (Stärke mm. 12).

Table à manger avec piètement en noyer canaletta ou frêne massif fixé sur une plaque en métal et plateau en verre trempé (épaisseur mm. 12).

Mesa de comedor con base de nogal canaletta o fresno macizo montada sobre de un disco de metal y tapa en cristal templado (espesor mm. 12).

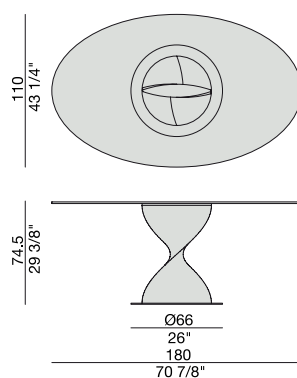

ESSENZE | *Essences*



Noce Canaletta
Canaletta Walnut

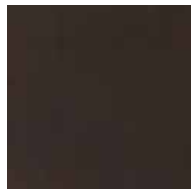

Noce Canaletta
Canaletta Walnut
tinto/stained moka



Noce Canaletta
Canaletta Walnut
tinto/stained wengé



Frassino Naturale
Natural Ash

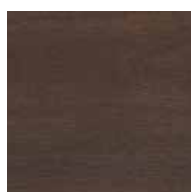

Frassino
Ash
tinto/stained moka

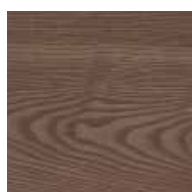

Frassino
Ash
tinto noce canaletta
canaletta walnut stained

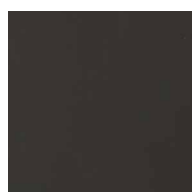

Frassino
Ash
tinto/stained wengé



Frassino
Ash
tinto/stained canapa

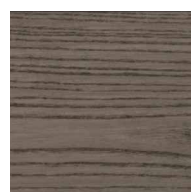

Frassino
Ash
tinto/stained caffè

LACCATO OPACO PORO CHIUSO | *Matt lacquered closed pore*

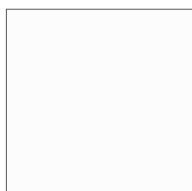

Bianco
White
(RAL 9016)

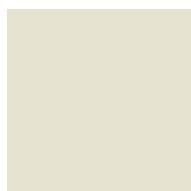

Avorio
Ivory
(RAL 1013)



Argilla
Mud
(RAL 7006)



Piombo
Lead
(NCS S5005G20Y)



Cioccolato
Chocolate
(RAL 8019)

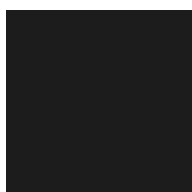

Nero
Black
(RAL 9005)



Granata
Garnet red
(NCS S4050Y90R)



Pistacchio
Pistachio green
(PANTONE 5825)



Avio
Aviation blue
(PANTONE 5415)

LACCATO OPACO PORO APERTO | *Matt lacquered open pore*

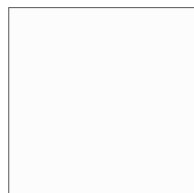

Bianco
White
(RAL 9016)

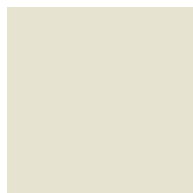

Avorio
Ivory
(RAL 1013)



Argilla
Mud
(RAL 7006)



Piombo
Lead
(NCS S5005G20Y)



Cioccolato
Chocolate
(RAL 8019)

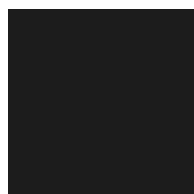

Nero
Black
(RAL 9005)



Granata
Garnet red
(NCS S4050Y90R)



Pistacchio
Pistachio green
(PANTONE 5825)



Avio
Aviation blue
(PANTONE 5415)

CRISTALLO | *Glass*



Trasparente
Transparent

METALLO | *Metal*

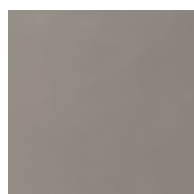

Cromo satinato
Satin chromed

ELIKA 180 BRILLANTE

G. Carollo

2011

Tavolo da pranzo con base centrale in tecnopolimero strutturale montata su una piastra in metallo e piano in cristallo temperato (spessore mm. 12).

Dining-table with base in structural technopolymer fixed on a metal ring and tempered glass top (thickness mm. 12).

Ess-Tisch mit Gestell aus Strukturel Technopolymer auf eine Metallplatte und ESG-Glasplatte (Stärke mm. 12).

Table à manger avec piétement en technopolymère structural fixé sur une plaque en métal et plateau en verre trempé (épaisseur mm. 12).

Mesa de comedor con base de tecnopolímero montada sobre de un disco de metal y tapa en cristal templado (espesor mm. 12).

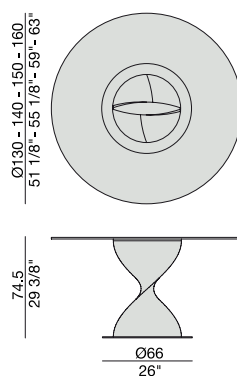
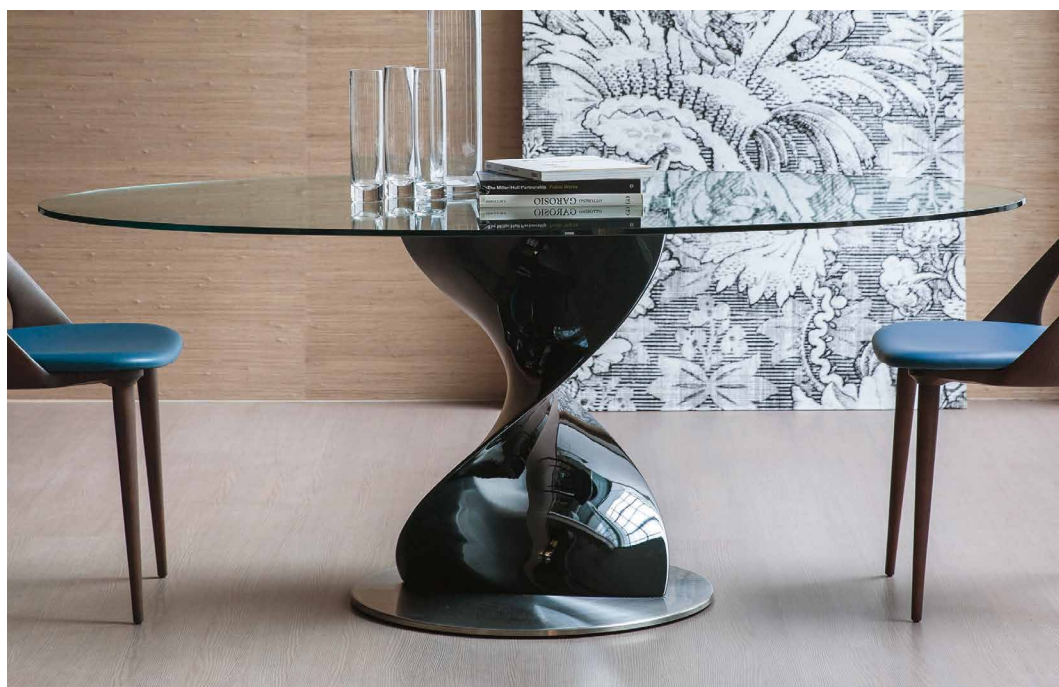

ELIKA 180 BRILLANTE

G. Carollo

2011

TECNOPOLIMERO | *Technopolymer*

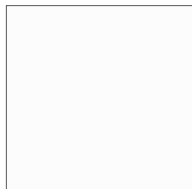

Bianco brillante
Shiny White

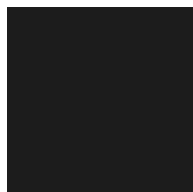

Nero brillante
Shiny Black

CRISTALLO | *Glass*

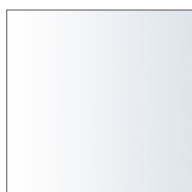

Trasparente
Transparent

METALLO | *Metal*

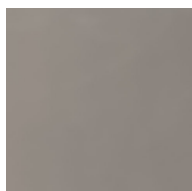

Cromo satinato
Satin chromed

ELIKA 2 BASI

G. Carollo

2011

Tavolo da pranzo con due basi in massello di noce canaletta o frassino montate su piastre in metallo e piano in cristallo temperato (spessore mm. 12).

Dining-table with two bases in solid canaletta walnut or ash fixed on metal rings and tempered glass top (thickness mm. 12).

Ess-Tisch mit zwei Gestellen aus massivem Nussbaum Canaletta oder Esche auf Metallplatten und ESG-Glasplatte (Stärke mm. 12).

Table à manger avec deux piétements en noyer canaletta ou frêne massif fixés sur plaques en métal et plateau en verre trempé (épaisseur mm. 12).

Mesa de comedor con dos bases de nogal canaletta o fresno macizo montadas sobre de discos de metal y tapa en cristal templado (espesor mm. 12).

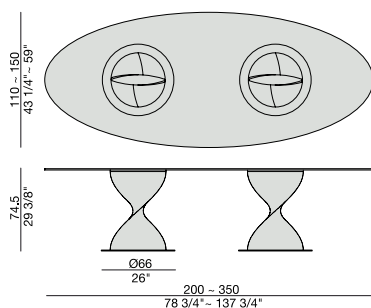
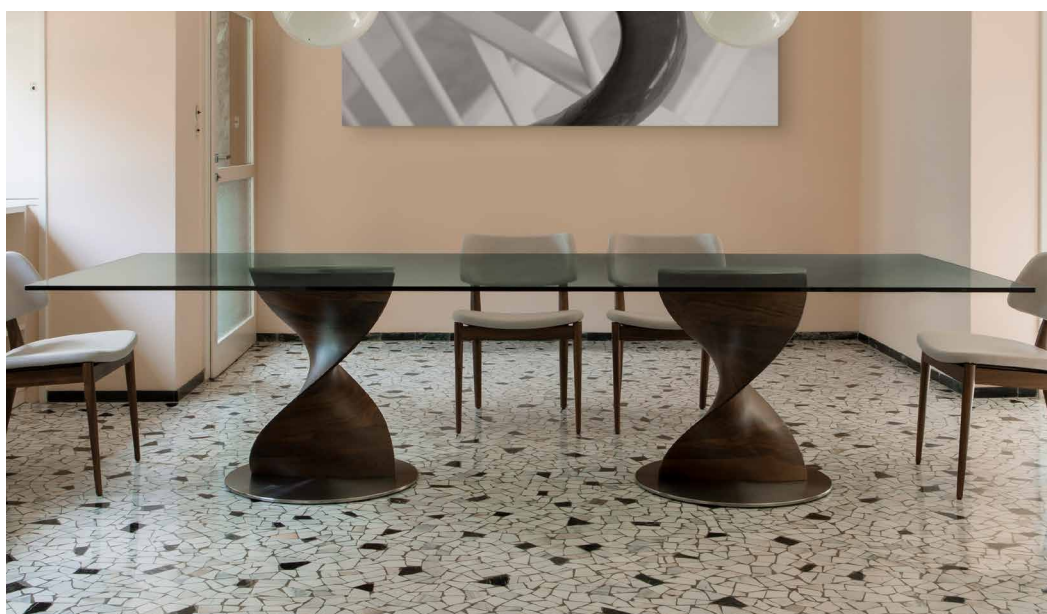

2 BASI ELLITTICO
Elliptical 2 bases

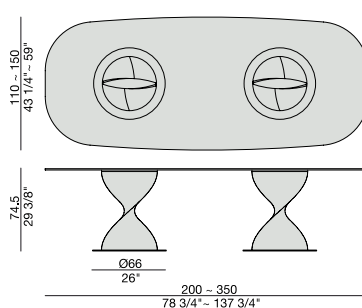

2 BASI OVALE
Oval 2 bases

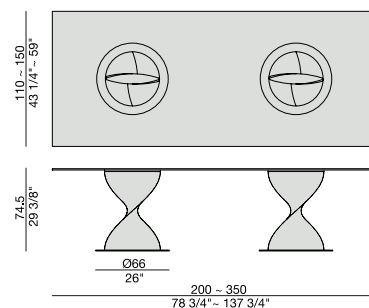

2 BASI RETTANGOLARE
Rectangular 2 bases

ELIKA 2 BASI

G. Carollo

2011

ESSENZE | *Essences*



Noce Canaletta
Canaletta Walnut

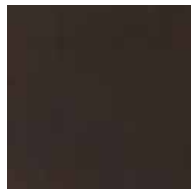

Noce Canaletta
Canaletta Walnut
tinto/stained moka



Noce Canaletta
Canaletta Walnut
tinto/stained wengé



Frassino Naturale
Natural Ash

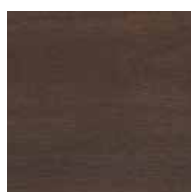

Frassino
Ash
tinto/stained moka

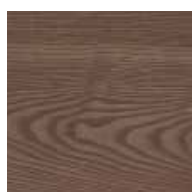

Frassino
Ash
tinto noce canaletta
canaletta walnut stained

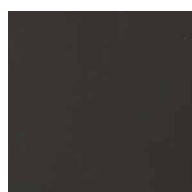

Frassino
Ash
tinto/stained wengé



Frassino
Ash
tinto/stained canapa

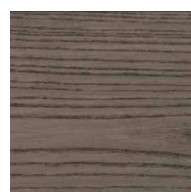

Frassino
Ash
tinto/stained caffè

LACCATO OPACO PORO CHIUSO | *Matt lacquered closed pore*

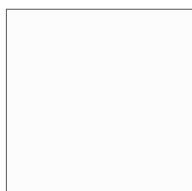

Bianco
White
(RAL 9016)

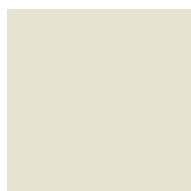

Avorio
Ivory
(RAL 1013)



Argilla
Mud
(RAL 7006)



Piombo
Lead
(NCS S5005G20Y)



Cioccolato
Chocolate
(RAL 8019)

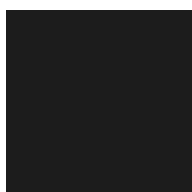

Nero
Black
(RAL 9005)



Granata
Garnet red
(NCS S4050Y90R)



Pistacchio
Pistachio green
(PANTONE 5825)



Avio
Aviation blue
(PANTONE 5415)

ELIKA 2 BASI

G. Carollo

2011

LACCATO OPACO PORO APERTO | *Matt lacquered open pore*

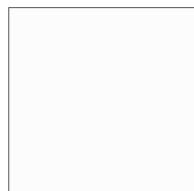

Bianco
White
(RAL 9016)

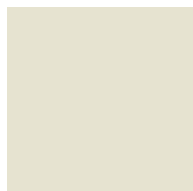

Avorio
Ivory
(RAL 1013)



Argilla
Mud
(RAL 7006)



Piombo
Lead
(NCS S5005G20Y)



Cioccolato
Chocolate
(RAL 8019)



Nero
Black
(RAL 9005)



Granata
Garnet red
(NCS S4050Y90R)



Pistacchio
Pistachio green
(PANTONE 5825)



Avio
Aviation blue
(PANTONE 5415)

CRISTALLO | *Glass*



Trasparente
Transparent

METALLO | *Metal*

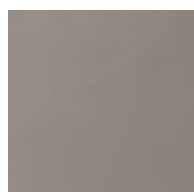

Cromo satinato
Satin chromed

ELIKA 2 BASI BRILLANTE

G. Carollo

2011

Tavolo da pranzo con due basi centrale in tecnopolimero strutturale montata su una piastra in metallo e piano in cristallo temperato (spessore mm.12).

Dining-table with two bases in structural technopolymer fixed on a metal ring and tempered glass top (thickness mm. 12).

Ess-Tisch mit zwei Gestellen aus Strukturel Technopolymer auf eine Metallplatte und ESG-Glasplatte (Stärke mm. 12).

Table à manger avec deux dépiétements en technopolymère structural fixé sur une plaque en métal et plateau en verre trempé (épaisseur mm. 12).

Mesa de comedor con base de tecnopolímero montada sobre de un disco de metal y tapa en cristal templado (espesor mm. 12).

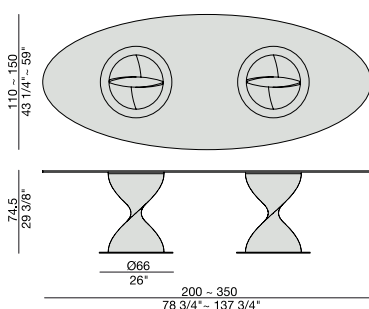

2 BASI ELLITTICO
Elliptical 2 bases

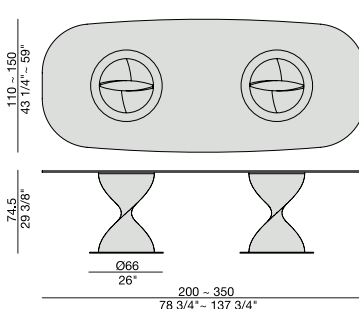

2 BASI OVALE
Oval 2 bases

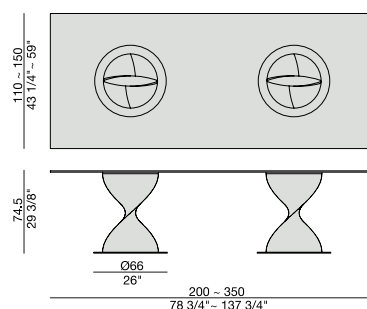

2 BASI RETTANGOLARE
Rectangular 2 bases

ELIKA 2 BASI BRILLANTE

G. Carollo

2011

TECNOPOLIMERO | *Technopolymer*

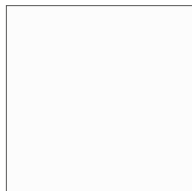

Bianco brillante
Shiny White

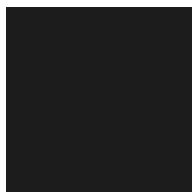

Nero brillante
Shiny Black

CRISTALLO | *Glass*

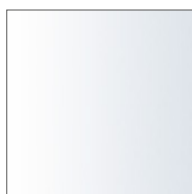

Trasparente
Transparent

METALLO | *Metal*

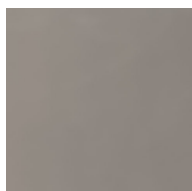

Cromo satinato
Satin chromed