

# RETRÒ 1

M. Marconato - T. Zappa

Tavolo da pranzo con base in massello di noce canaletta. Insetto in metallo e piano tondo in cristallo bisellato (spessore mm. 15).

*Dining-table with base in solid canaletta walnut. Metal central structure and bevelled glass top (thickness mm. 15).*

*Ess-Tisch mit Gestell aus massivem Nussbaum Canaletta. Metallverbindung und Glasplatte (mit einer Stärke von mm. 15).*

*Table à manger avec piétement en noyer canaletta massif. Joint en métal et plateau en verre (épaisseur mm. 15).*

*Mesa de comedor con base en nogal canaletta macizo. Inserción en metal y tapa en cristal biselado (espesor mm. 15).*

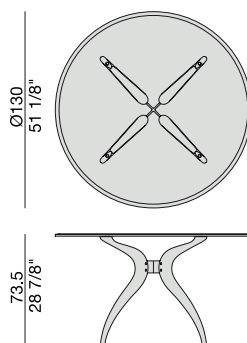

## ESSENZE | *Essences*



**Noce Canaletta**  
Canaletta Walnut



**Noce Canaletta**  
Canaletta Walnut  
*tinto/stained moka*



**Noce Canaletta**  
Canaletta Walnut  
*tinto/stained wengé*

## LACCATO OPACO PORO CHIUSO | *Matt lacquered closed pore*

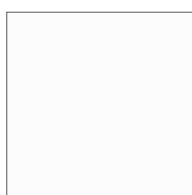

**Bianco**  
White  
(RAL 9016)

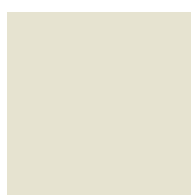

**Avorio**  
Ivory  
(RAL 1013)



**Argilla**  
Mud  
(RAL 7006)



**Piombo**  
Lead  
(NCS S5005G20Y)



**Cioccolato**  
Chocolate  
(RAL 8019)

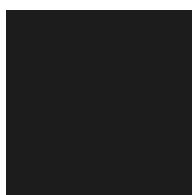

**Nero**  
Black  
(RAL 9005)



**Granata**  
Garnet red  
(NCS S4050Y90R)



**Pistacchio**  
Pistachio green  
(PANTONE 5825)



**Avio**  
Aviation blue  
(PANTONE 5415)

# RETRÒ 1

M. Marconato - T. Zappa

---

## CRISTALLO TRASPARENTE | *Transparent glass*

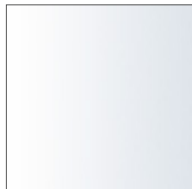

Bianco  
White

## METALLO | *Metal*

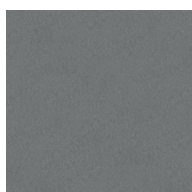

Grigio Peltro  
Grey Pewter

# RETRÒ 2

M. Marconato - T. Zappa

Tavolo da pranzo con base in massello di noce canaletta. Inserto in metallo e piano ovale in cristallo bisellato (spessore mm. 15).

*Dining-table with base in solid canaletta walnut. Metal central structure and bevelled glass top (thickness mm. 15).*

*Ess-Tisch mit Gestell aus massivem Nussbaum Canaletta. Metallverbindung und Glasplatte (mit einer Stärke von mm. 15).*

*Table à manger avec piétement en noyer canaletta massif. Joint en métal et plateau en verre (épaisseur mm. 15).*

*Mesa de comedor con base en nogal canaletta macizo. Inserción en metal y tapa en cristal biselado (espesor mm. 15).*

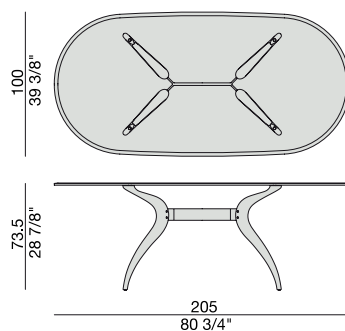

# RETRÒ 2

M. Marconato - T. Zappa

---

## ESSENZE | *Essences*



**Noce Canaletta**  
Canaletta Walnut

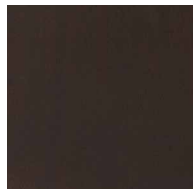

**Noce Canaletta**  
Canaletta Walnut  
*tinto/stained moka*



**Noce Canaletta**  
Canaletta Walnut  
*tinto/stained wengé*

## LACCATO OPACO PORO CHIUSO | *Matt lacquered closed pore*

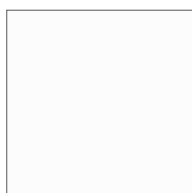

**Bianco**  
White  
(RAL 9016)

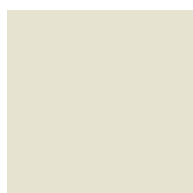

**Avorio**  
Ivory  
(RAL 1013)



**Argilla**  
Mud  
(RAL 7006)



**Piombo**  
Lead  
(NCS S5005G20Y)



**Cioccolato**  
Chocolate  
(RAL 8019)

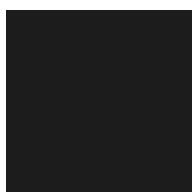

**Nero**  
Black  
(RAL 9005)



**Granata**  
Garnet red  
(NCS S4050Y90R)



**Pistacchio**  
Pistachio green  
(PANTONE 5825)



**Avio**  
Aviation blue  
(PANTONE 5415)

# RETRÒ 2

M. Marconato - T. Zappa

---

## CRISTALLO TRASPARENTE | *Transparent glass*

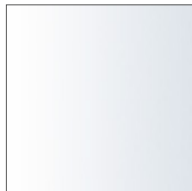

Bianco  
White

## METALLO | *Metal*



Grigio Peltro  
Grey Pewter

# RETRÒ 4

M. Marconato - T. Zappa

Tavolo da pranzo con base in massello di noce canaletta. Inserto in metallo e piano a botte in cristallo bisellato (spessore mm. 15).

*Dining-table with base in solid canaletta walnut. Metal central structure and bevelled glass top (thickness mm. 15).*

*Ess-Tisch mit Gestell aus massivem Nussbaum Canaletta. Metallverbindung und Glasplatte (mit einer Stärke von mm. 15).*

*Table à manger avec piètement en noyer canaletta massif. Joint en métal et plateau en verre (épaisseur mm. 15).*

*Mesa de comedor con base en nogal canaletta macizo. Inserción en metal y tapa en cristal biselado (espesor mm. 15).*

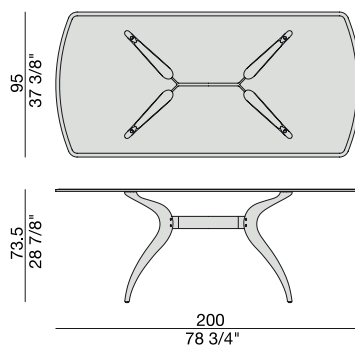

# RETRÒ 4

M. Marconato - T. Zappa

## ESSENZE | *Essences*



**Noce Canaletta**  
Canaletta Walnut

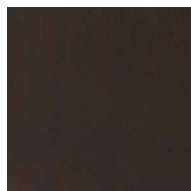

**Noce Canaletta**  
Canaletta Walnut  
*tinto/stained moka*



**Noce Canaletta**  
Canaletta Walnut  
*tinto/stained wengé*

## LACCATO OPACO PORO CHIUSO | *Matt lacquered closed pore*

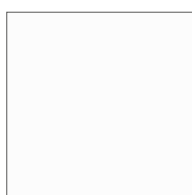

**Bianco**  
White  
(RAL 9016)



**Avorio**  
Ivory  
(RAL 1013)



**Argilla**  
Mud  
(RAL 7006)



**Piombo**  
Lead  
(NCS S5005G20Y)



**Cioccolato**  
Chocolate  
(RAL 8019)

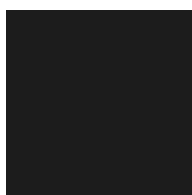

**Nero**  
Black  
(RAL 9005)



**Granata**  
Garnet red  
(NCS S4050Y90R)



**Pistacchio**  
Pistachio green  
(PANTONE 5825)



**Avio**  
Aviation blue  
(PANTONE 5415)



# RETRÒ 4

M. Marconato - T. Zappa

---

## CRISTALLO TRASPARENTE | *Transparent glass*

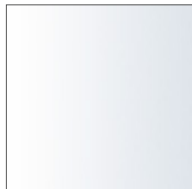

Bianco  
White

## METALLO | *Metal*



Grigio Peltro  
Grey Pewter