

VOLUME (l)
VOLUMEN (l)

MAX. LOAD (kg)
MAX. BELASTUNG (kg)

FLOOR LOAD (kg/m²)
BODENBELASTUNG (kg/m²)

720

930

340

- - Spot for el. cable 3×2.5mm², length approx. 2m
- Platz Stromkabel 3 × 2,5 mm², Länge cca. 2 m
- - Spot for el. cable 1×6mm² for earthing, length approx. 2m
- Platz Stromkabel 1 × 6 mm² für Erdung, Länge cca. 2 m

- ⊠ - Connection of hot and cold water 1/2" min 0.2Mpa, max 0.4Mpa
- Anschluss Warm- und Kaltwasser 1/2" min 0,2 Mpa, max 0,4 Mpa

- - Drain spot Ø 50mm
- Abflussplatz Ø 50 mm
- ▨ - Panel - option
- Möglichkeit - Schürze

INSTALLATION RECOMMENDATION
MONTAGEEMPFEHLUNG

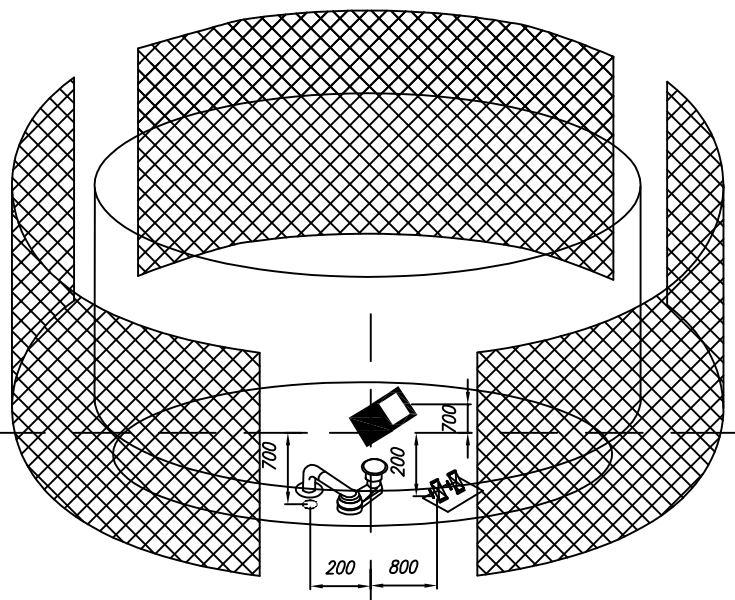

Recommendations for the installation of bathtub without panel
Empfehlungen für die Montage von Badewannen ohne Schürze









Nr. MK 02

Recommendations for the installation of bathtub with panel
Empfehlungen für die Montage von Badewannen mit Schürze

Nr. MK 01

Option of the bathtub base with panel
Möglichkeit des Sockels für die Badewannen mit Schürze

pre-assembled
vormontiert

- | | | | | |
|---|---|--|--|--|
|  - PUMP
- WASSERPUMPE |  - WATER JETS
- WASSERDÜSEN |  - AIR CONTROLLER
- LUFTREGLER |  - ELECTRONIC SWITCHES
- ELEKTROSCHALTER |  - FIXTURE AND SHOWER HANDLE
- WASSERHAHN UND DUSCHE |
|  - BLOWER
- LUFTPUMPE |  - AIR JET
- LUFTDÜSE | |  - LIGHT OR CHROMOTHERAPY
- LICHT- ODER CHROMOTHERAPIE |  - MICROJET SWITCH
- SCHALTER FÜR MIKRODÜSEN |

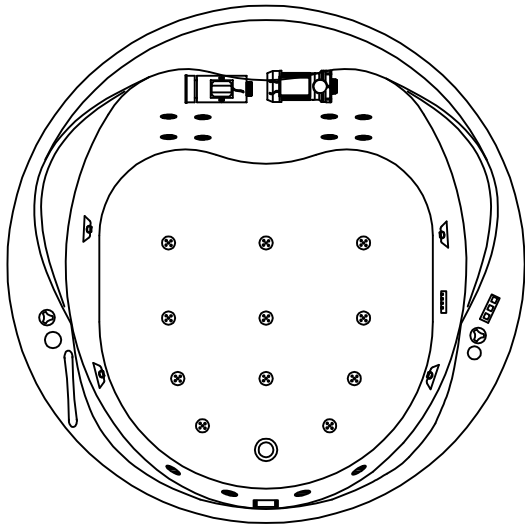

WATER AND AIR MASSAGE SYSTEM

- PUMP P=1250W
- BLOWER P=800W
- ELECTRONIC SWITCH
- 2x AIR CONTROLLER
- 4 SUPER WATER JETS
- 11 AIR JETS
- 2x4 MICROJETS FOR BACK
- 4 MICROJETS FOR FEET

WASSER UND LUFT MASSAGESYSTEM

- WASSERPUMPE P = 1250 W
- LUFTPUMPE P = 800 W
- ELEKTROSCHALTER
- 2x LUFTREGLER
- 4 SUPER WASSERDÜSEN
- 11 LUFTDÜSEN
- 2 x 4 MIKRODÜSEN FÜR RÜCKEN
- 4 MIKRODÜSEN FÜR FÜSSE

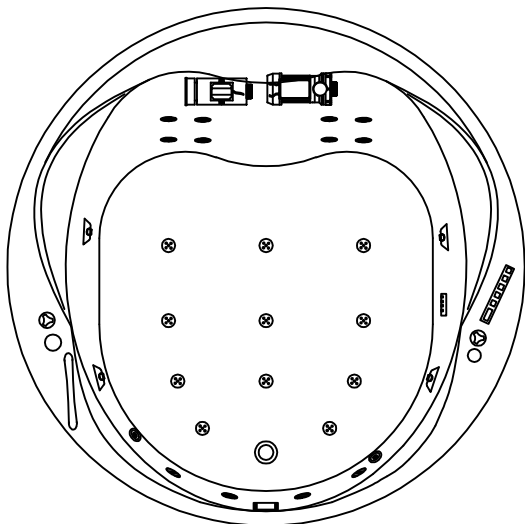

VITAL MASSAGE SYSTEM

- PUMP P=1250W
- BLOWER P=800W
- HEATER P=1500W
- ELECTRONIC SWITCH
- 2x AIR CONTROLLER
- 4 SUPER WATER JETS
- 11 AIR JETS
- OZONE FOR DISINFECTION
- CHROMOTHERAPY
- 2x4 MICROJETS FOR BACK
- 4 MICROJETS FOR FEET

VITAL MASSAGESYSTEM

- WASSERPUMPE P = 1250 W
- LUFTPUMPE P = 800 W
- HEIZKÖRPER P = 1500 W
- ELEKTROSCHALTER
- 2x AIR CONTROLLER
- 4 SUPER WASSERDÜSEN
- 11 LUFTDÜSEN
- OZON FÜR DESINFEKTION
- CHROMOTHERAPIE
- 2 x 4 MIKRODÜSEN FÜR RÜCKEN
- 4 MIKRODÜSEN FÜR FÜSSE

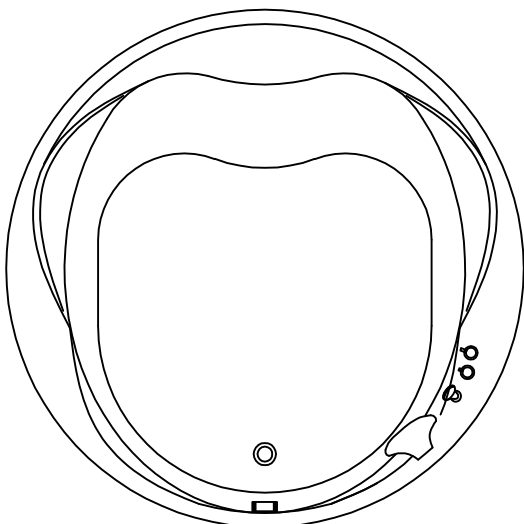

- OPTION FIXTURE AND SHOWER HANDLE - MÖGLICHKEIT WASSERHAHN UND DUSCHE