

**PREINSTALLATION
VORINSTALLATION**

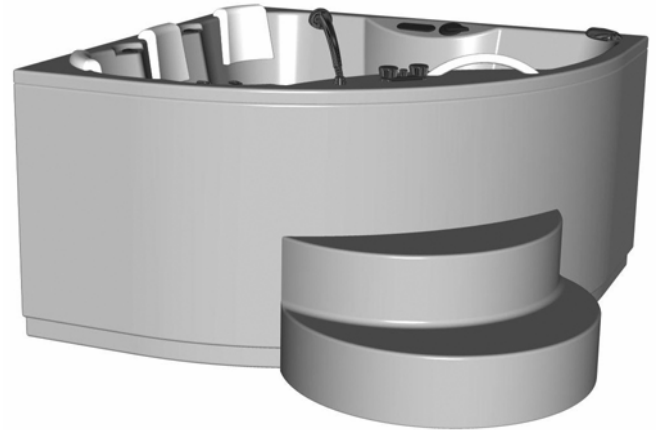
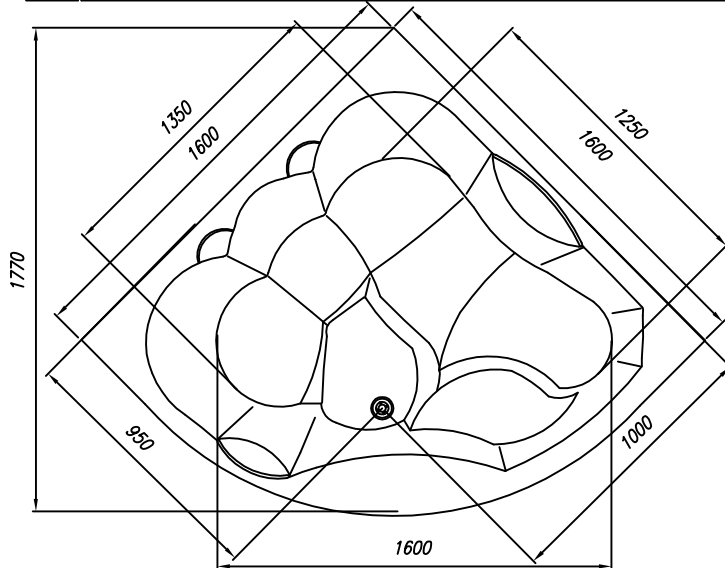
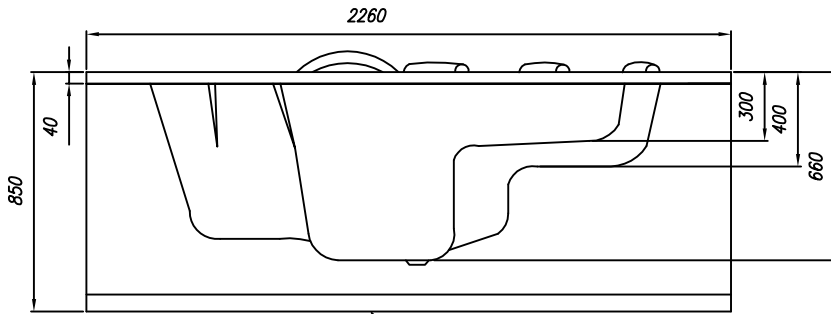
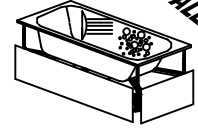

VOLUME (l)	MAX. LOAD (kg)	FLOOR LOAD (kg/m ²)
VOLUMEN (l)	MAX. BELASTUNG (kg)	BODENBELASTUNG (kg/m ²)

550

960

340

- - Spot for el. cable 3×2.5mm² (230V, 16A/L, N, ≍); L = 2.5m
- Platz Stromkabel 3 × 2,5 mm² (230 V, 16 A/L, N, ≍); L = 2,5 m
- - Spot for el. cable 1×6mm² for earthing, length approx. 2.5m
- Platz Stromkabel 1 × 6 mm² für Erdung, Länge cca. 2,5 m

- ⊠ - Connection of hot and cold water 1/2" min 0.2Mpa, max 0.4Mpa
- Anschluss Warm- und Kaltwasser 1/2" min 0,2 Mpa, max 0,4 Mpa

- - Drain spot Ø 50mm
- Abflussplatz Ø 50 mm

- ▣ - Panel - option
- Möglichkeit - Schürze

- Option - step
- Möglichkeit - Tritt

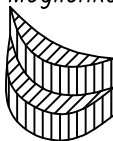

**INSTALLATION RECOMMENDATION
MONTAGEEMPFEHLUNG**

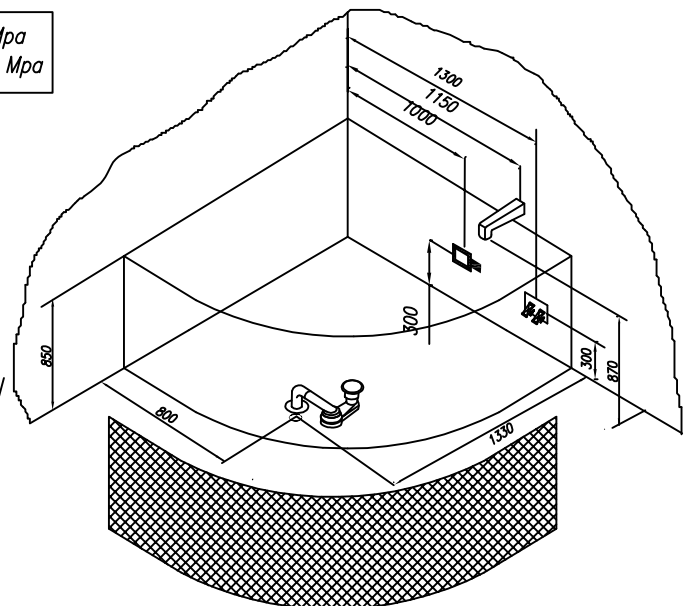

Recommendations for the installation of bathtub without panel Empfehlungen für die Montage von Badewannen ohne Schürze	Nr. MK 02
Recommendations for the installation of bathtub with panel Empfehlungen für die Montage von Badewannen mit Schürze	Nr. MK 01
Option of the bathtub base with panel Möglichkeit des Sockels für die Badewannen mit Schürze	pre-assembled vormontiert

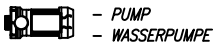

- PUMP
- WASSERPUMPE

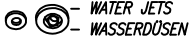

- WATER JETS
- WASSERDÜSEN



- AIR CONTROLLER
- LUFTREGLER



- ELECTRONIC SWITCHES
- ELEKTROSCHALTER



- FIXTURE AND SHOWER HANDLE
- WASSERHAHN UND DUSCHE

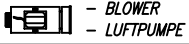

- BLOWER
- LUFTPUMPE



- AIR JET
- LUFTDÜSE

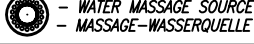

- WATER MASSAGE SOURCE
- MASSAGE-WASSERQUELLE



- LIGHT OR CHROMOTHERAPY
- LICHT- ODER CHROMOTHERAPIE

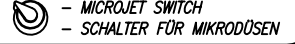

- MICROJET SWITCH
- SCHALTER FÜR MIKRODÜSEN

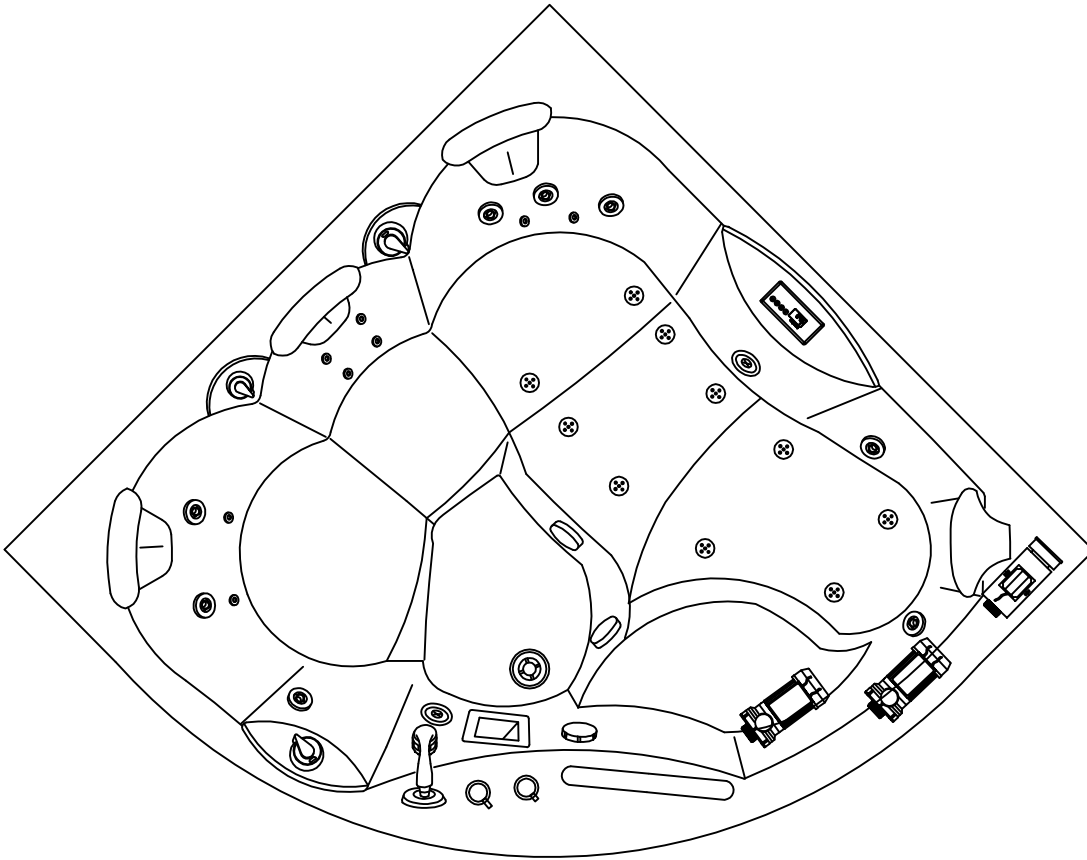

LUXUS+ MASSAGE SYSTEM

- PUMP P=1250W
- PUMP P=650W
- BLOWER P=800W
- HEATER P=2000W
- ELECTRONIC SWITCH
- 2x AIR CONTROLLER
- 8 WATER MICRO JETS
- 8 SUPER WATER JETS
- 10 AIR JETS
- WATER FILTRATION
- CHROMOTHERAPY
- FIXTURE AND SHOWER HANDLE
- OZONE FOR DISINFECTION

LUXUS+ MASSAGESYSTEM

- WASSERPUMPE P = 1250 W
- WASSERPUMPE P = 650 W
- LUFTPUMPE P = 800 W
- HEIZKÖRPER P = 2000 W
- ELEKTROSCHALTER
- 2x LUFTREGLERAIR
- 8 MIKRO-WASSERDÜSEN
- 8 SUPER-WASSERDÜSEN
- 10 LUFTDÜSEN
- WASSERFILTRIERUNG
- CHROMOTHERAPIE
- WASSERHAHN UND DUSCHE
- OZON FÜR DESINFEKTION

- OPTION STEP - ACRYL

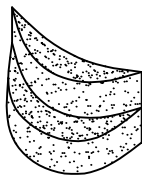

- MÖGLICHKEIT TRITT - ACRYL