



OUTDOOR SPA

SPA-318

PROGRAMMING INSTRUCTIONS



RAMMING INSTRUCTIONS

1. Illustration to buttons

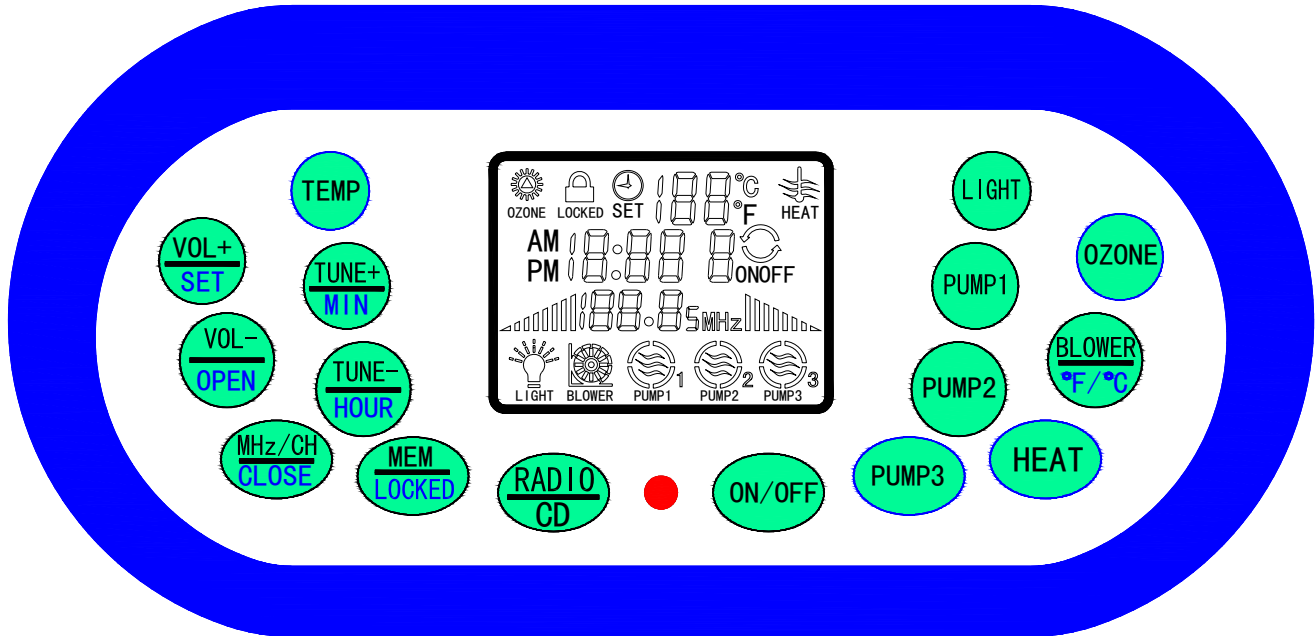

















Fig . 1: Sketch map of big massage bathtub

“  ” Frequency up- searching / Minute	“  ” On/ Off
“  ” Frequency down- searching/ Hour	“  ” Radio & CD Input On/ Off
“  ” Volume up/ Set switch	“  ” Blower on/ Off & Temperature Mode Shift
“  ” Volume down/ Open	“  ” Light from the bottom on/ Off
“  ” Radio memory/ Lock	“  ” Surf Water pump 1 on/ Off
“  ” Radio searching / Close	“  ” Surf Water pump 1 on/ Off
“  ” Circulation cleaning set of ozone/ On/Off	“  ” Setting Of circulation Cleaning & Surf Water pump 3 on/ Off.
“  ” Preheat setting & Heater On/ Off	“  ” Temperature setting
Note: .Function of buttons with blue parts only works under the <u>power-off status.</u>	

2. Function Summary

(1) Constant temperature, preset heater, and display and operation of water temperature.

- (2) Display and set of 12 hours am/ pm model.
- (3) Circulation cleaning.
- (4) CD frequency input. Display of radio frequency and storage for 10 channels.
- (5) Display and 87 grades adjustment of volume.
- (6) Infrared remote control.
- (7) one ozone set and one bottom light.
- (8) Frozen preventing control.
- (9) Power loss memory for all setting.
- (10) Fahrenheit & Celsius temperature shift.
- (11) Three surfing pumps, And PUMP3 is circulation pump also, One blower.
- (12) Lock of buttons of computer board.
- (13) Selection of 110-120VAC or 220-240VAC.
- (14) Selection one AC power output when “CD” is working, This is using for DVD or TV.

3. Operations

(1) When first turning on the power, the backlight will bright or halt, and the LCD will show the present time and temperature. It will show “E1” if the sensor is open/short circuit. When part of radio frequency showed “---”, it indicates that the status of the system is “power off”, so as well as the pre-heat and circulation cleaning.



Fig . 3: Normal temperature.

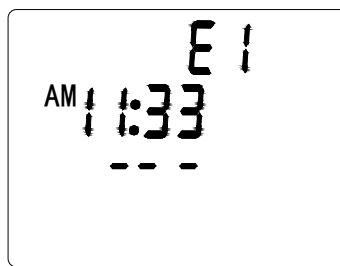









Fig . 4: Sensor open circuit or short circuit

(2) Lock Operation :

The lock will start work by pressing “” Button in the status of “power off” or no-pressing operation lasting above 30 minute. In the status of Locked, press the button “” twice, the lock will be unlocked. and the word “LOCKED” will disappear.

(3) Time setting operation:

In the status of “Power off” and the pre-heater and circulation cleaning are shut down, pressing “” or “” could start time setting. Signal of “:” doesn’t flash but Minute and Hour flash at this time. It will add 1 hour when pressing “” each time, and the hours could be added continually when pressing the “” without stop. The hour adjustment range is AM 0~PM 11.

In the status of time setting, It will add 1 minute when pressing “” each time, and the minutes could be added continually when pressing the “” without stop. the minute adjustment range of the minute is: 0~59.

The system will quit the time-setting status automatically after 6 seconds without pressing.

(4) Operation to circulation-cleaning settings:

Circulation-cleaning only works one times every day。 The LCD can show clearly about whether circulation-cleaning setting is startup or not。 See following Fig . 5-6。

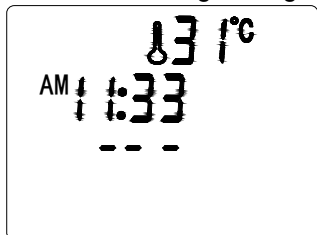

Fig . 5: Circulation-cleaning off

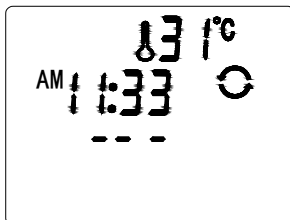













Fig . 6: Circulation-cleaning on

Circulation-cleaning setting must be in the “Power off” status and the LCD display “---”。

- 1) 、 Press “  ”, and enter to Circulation-cleaning setting status, and the LCD flashes of “  ”。
- 2) 、 Press “  ”, can turn on Circulation-cleaning setting status (by opposite, if press “  ” it will turn off the Circulation-cleaning), And this time, “  ” on LCD will not flash。 When the system enter into time setting of Circulation-cleaning, the setting time will flash on the LCD (this time is the Circulation-cleaning time which will start), at this moment, only “  ” and “  ” are available to change the time。





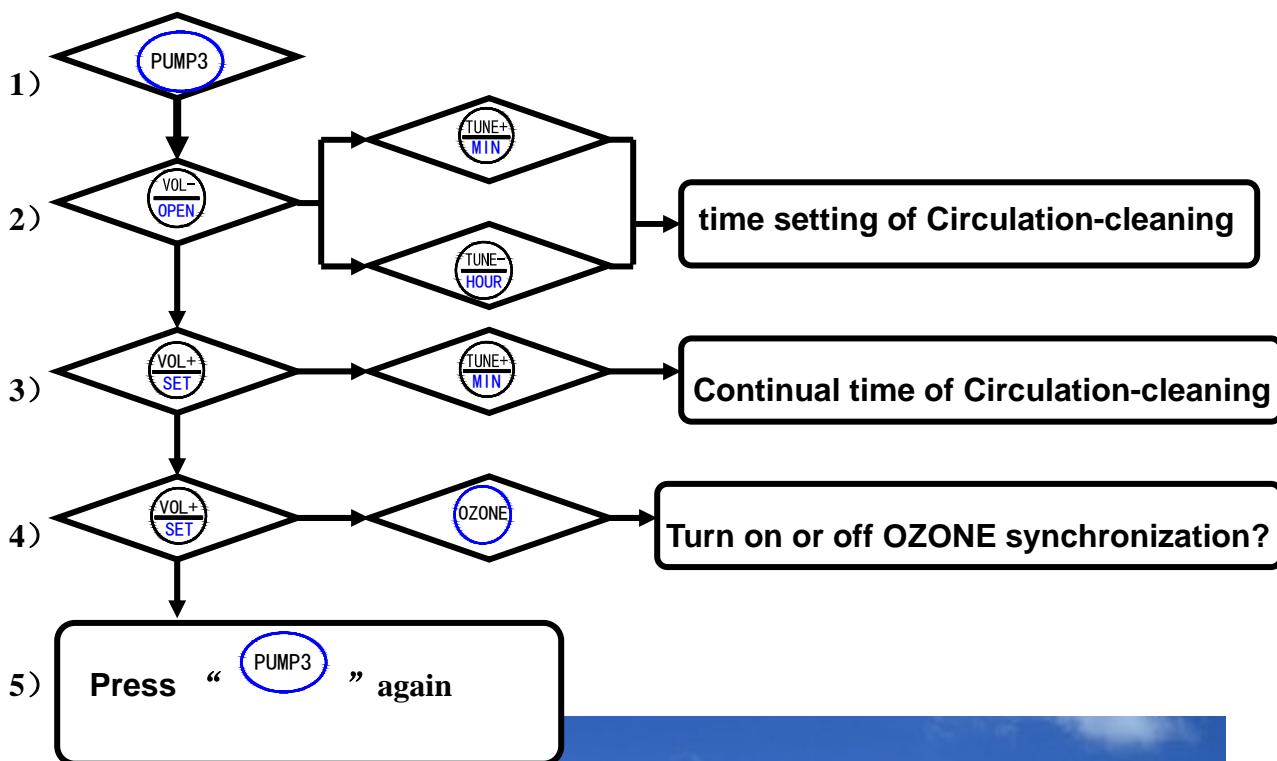

It will add 1 minute when pressing “  ” each time and the minutes could be added the continually when pressing the “  ” without stop。 The adjustment range is 0~59。

It will add 1 hour when pressing “  ” each time, and the hours could be added the continually when pressing the “  ” without stop。 The adjustment range is AM 0~PM 11。

And after time setting of Circulation-cleaning, you could go on to next step。



the setting will be finished

- 3)、Press “  ” to continual time setting of Circulation-cleaning, it will show the minimum continue time is 1 minutes on the LCD, and this time will not flash. It will add 5 minutes by pressing “  ” each time, please note that the maximum of continual time is 30 minutes. When you set up well of the continual time, you could go on to the next step.
- 4)、Press “  ” again to turn on or off OZONE synchronization. “  ” of LCD will flash, This is mean OZONE is turned off synchronization. Press “  ” can turn on OZONE synchronization.
- 5)、When everything is setting well, Press “  ” again, the system will quit the Circulation-cleaning setting status.

***** Notice *****

- 1、all setting of Circulation-cleaning must be in Power OFF status.
- 2、Circulation PUMP and OZONE are not working while all setting time.

(5) Pre-heating setting:

Only one pre-heating setting is allowed each day. The LCD can show clearly in the following figures about whether pre-heating settings are started up or not.

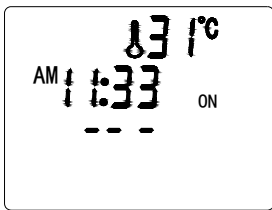

Fig . 7: Pre-heat On

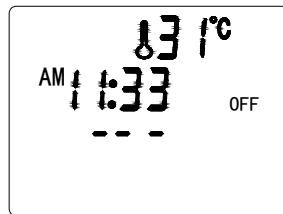
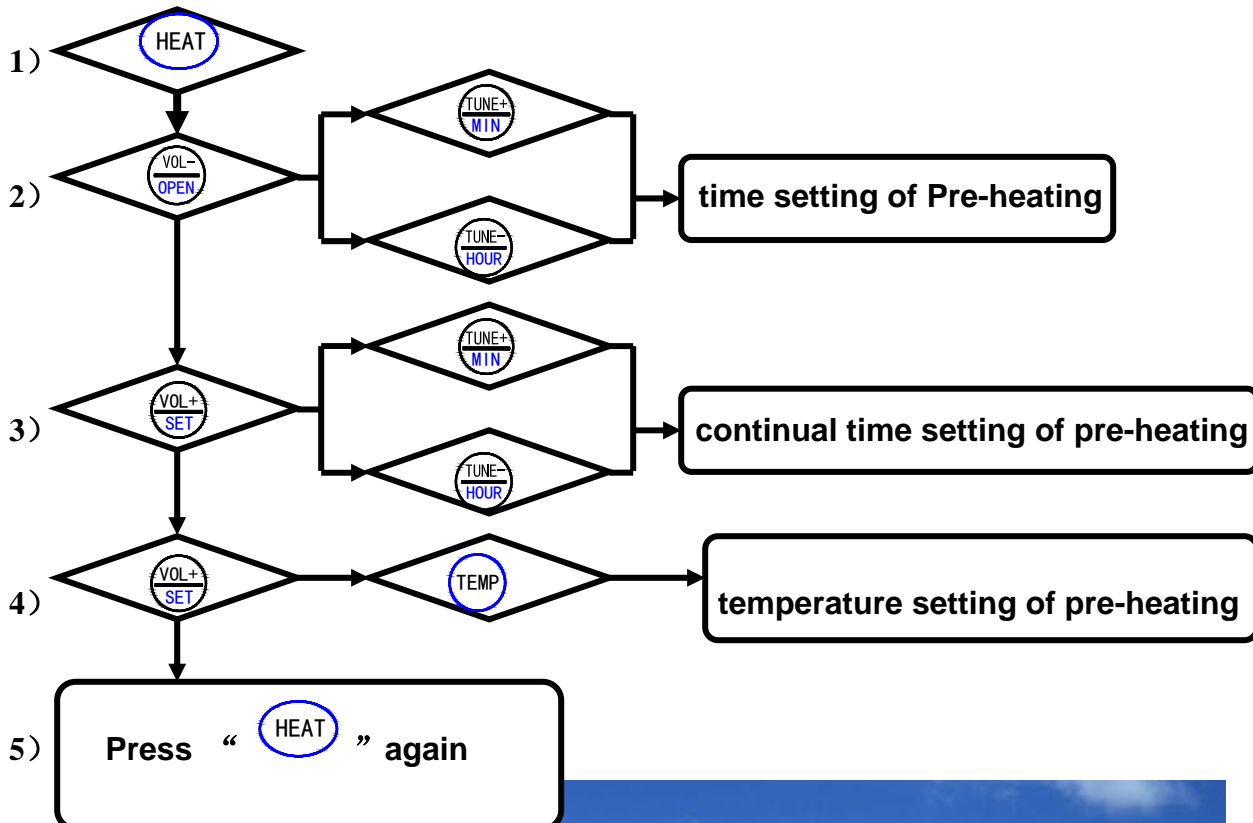

Fig . 8: Pre-heat Off



the setting will be finished

Pre-heating setting is in the "Power off" status and the LCD display "---".

- 1、 Press "HEAT", and enter to Pre-heating setting status, and the LCD flashes of "ON OFF".
- 2、 Press "VOL- / OPEN", can turn on the pre-heating setting (by opposite, if press "MHz/CH / CLOSE", it will turn off the pre-heating), and at this time, "ONOFF" on LCD will turn to "ON", and will not flash (if press "MHz/CH / CLOSE" to turn off pre-heating, LCD will display "OFF" which do not flash there). When the system enter into time setting of pre-heating, the setting time will flash on the LCD (this time is the pre-heating time which will start), at this moment, only "TUNE+ / MIN" and "TUNE- / HOUR" are available to change the time.
It will add 1 minute when pressing "TUNE+ / MIN" each time and the minutes could be added the continually when pressing the "TUNE+ / MIN" without stop. The adjustment range is 0~59.
It will add 1 hour when pressing "TUNE- / HOUR" each time, and the hours could be added the continually when pressing the "TUNE- / HOUR" without stop. The adjustment range is AM 0~PM 11.
And after time setting of pre-heating, you could go on to next step.
- 3、 Press "VOL+ / SET" to continual time setting of pre-heating, it will show the minimum continue time is 10 minutes on the LCD, and this time will not flash. It will add 10 minutes by pressing "TUNE+ / MIN" each time, and it will add 1 hour when pressing "TUNE- / HOUR" each time, please note that the maximum of continual time is 19 hours and 50 minutes. When you set up well of the continual time, you could go on to the next step.
- 4、 Press "VOL+ / SET" again to the temperature setting of pre-heating. It will show "SET" label on the LCD panel, press "TEMP" and button could change the temperature setting. The range of temperature setting is 25~45°C.
- 5、 When everything is setting well, Press "HEAT" again, the system will quit the pre-heating setting status.

*** Notice ***

- 1、 all setting of pre-heating must be in Power OFF status, just connect the spa with the power supply. and the LCD display "---".
- 2、 please note that it shows "on" or "off" on the LCD, "on" means pre-heating is turn on, when the time of pre-heating is the same as currently time, the heater will start working. "off" means the heater can't start-up anytime.
- 3、 Circulation PUMP and HEATER are not working while all setting time.

(6) Pre-heating:

When the time of real time and pre-heating time is consistent, meanwhile, there is water in the bathtub and the pre-heating button is "on", the system will start the pre-heating and circulation pump and auto-constant temperature system will work at the same time. Then LCD will show count down time (the two middle spot will not flash any longer) and corresponding working status. In the pre-heating process, till cont down time

finished。 the pre-heating will be turned off automatically by system or by pressing the “ **HEAT** ” or “ **ON/OFF** ” key intentionally。

***** Notice *****

- 1、 When setting temperature is lower or equal water temperature, Even the Pre-heating is working but the circulation PUMP and HEATER are not working。
- 2、 When the HEATER is “1” frame, The power of circulation PUMP must reach 750W。
- 3、 Answer for condition of “2”, and the HEATER is not working, Please short the line of water press switch。

(7)circulation-cleaning:

When the time of real time and pre-heating time is consistent, meanwhile, there is water in the bathtub and the circulation-cleaning button is “on”, the system will start the circulation-cleaning, and the circulation pump and ozone(If it is on) will work at the same time。 Then LCD will show count down time。 In the circulation-cleaning process, till cont down time finished the circulation-cleaning will be turned off automatically by system or by pressing “ **ON/OFF** ” key intentionally。

(8) Operation to Power ON/ OFF

Pressing the key **ON/OFF** will enter from ON to OFF or OFF to ON。 At the same time, the LCD will show whether the power is on or off。

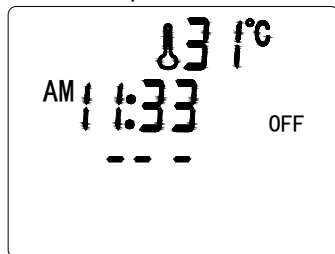

Fig . 9: OFF

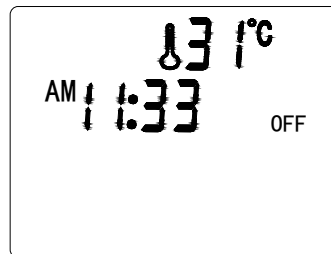

Fig . 10: ON

(9) Operation to Temperature setting

In the status of “Power-on” and “HEATER” is working , The temperature setting can operate。 only key “ **TEMP** ” are available, It will add 1°C when pressing “ **TEMP** ” and the temperature could be added continually till 45°C when pressing the “ **TEMP** ” without stop。 At this time , when pressing “ **TEMP** ” again, and the temperature could return 25°C 。 The range of adjustment is 25~45°C 。

(10)Operation Radio & CD:

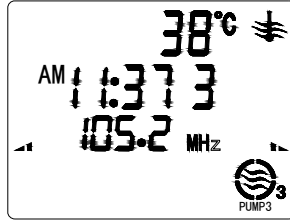









Fig . 11: Radio frequency is 105.2 MHZ, Save the present frequency to channel 3 (Save channel) or Exchange the frequency form channel 3 to the present (Searching channel)



I), Key  is the ON/OFF key for radio and CD. and it is only available in the status of power on. The first pressing is turning on the radio, the second pressing will turn off the radio and turn on the CD at the same time, and the third, will turn off the radio and CD simultaneous.

II), LCD will show present frequency and volume of the radio after turning on the radio.

III), In the working of radio, The volumn of the present radio frequency can be changed by pressing “  ” & “  ” .

IV), Pressing the key “  ” will take out the memorized radio frequency, Pressing the key “  ” continually will take out the memorized radio frequency from channels will be saved at present channel by pressing this key continually. If none of the channel, LCD will display “ --- ”.

V), Press the key “  ” could memorize the present radio frequency, Pressing the key “  ” continually will memorize the present radio frequency in different channel. The channel of max is 10, Name of channel is 0-9.

VI), The volume can be changed by pressing key “  ” & “  ” .

(11) Operation to Pump :

KEY of “Pump1” are control surf pump1. Key of “Pump2” are control surf pump2. Key of “Pump 3” are control surf pump3, Pump3 are circulation pump at the same time. The LCD will show  , when circulation and heating (Including preheating) are tune on , In spite of pump3 are on or off. PUMP1 & PUMP2 will auto off when working 2 hour later.

(12) Operation to Ozone:

The ozone could be started up in the status of circulation cleaning.

Press the key “  ” to turn on/off the ozone. After the startup of ozone, if the user would not change the working status of ozone, it will be turned off automatically 30 minutes later.

(13) Operation to Bottom lamp:

“  ” controlling the ON/OFF of the lamp in the bottom of the bathtub.

(14) Operation to Constant temperature heating:

- 1)、 When the pre-heating time is up (If the pre-heating has turned on) or press the “  ” will also start constant temperature heating system.
- 2)、 After the startup of constant temperature heating, circulation pump will be running all the while.

3)、 For example: if the temperature is set at 35°C, when the water temperature reaches or exceeds 36°C, the heater will be turned off automatically and the circulation pump will stop after 5 second (If PUMP3 is turn off)。 However, when the water temperature reach or lower than 34°C, the heater will start up。

4)、 When the temperature sensor is open/short (LCD shows "E1"), the auto temperature control system will not be available, Turning on/off the constant temperature system will turn on/off the heater。

(15) Operation to blower:

there is a key “  ” controlling the on/off of blower。
BLOWER will auto off when working 2 hour later。

(16) Fahrenheit & Celsius temperature shift:

In the status of“Power off”, pressing the key“  ” can change the mode of Fahrenheit & Celsius temperature 。

(17) When there is no water in the bathtub, water pumps, blower and constant temperature system will not start up。 However, the corresponding signal on the LCD will flash。

(18) Frozen preventing control:

The heater & circulation pump will on when water temperature is under 5°C, And will off when up 10°C。 The function is effective when power on。

4. Electric parameters

(1) Performance index:

Rated voltage: 220VAC/50Hz (110VAC/60Hz)。

Voltage-resistance: 1250V/1 minute without penetration。

Water resistance grade: IPX4。

Maximum working current: 60A (100A/110V)

Isolative resistance : $\geq 200M\Omega$

Electric shock resistance: first grade

(2) Output loading index

Heater: AC220V/3KW. Water pump: AC220V/2 HP×1

water pump: AC220V/0.35HP×1

Spa light: AC12V/20W

Radio: 1) Frequency Range: FM: 87.0~108.0MHz

2) Maximum Output Power: 10W

3) Speaker: 8Ω damp proof speaker

Water pump: AC220V/1.5HP×1

Air pump: AC220V/0.7KW×1

Ozone: AC12V/15W

Hydromassage bathtub water and power supply installs diagram

MODEL: SPA-318
SIZE:2080X1750X930mm

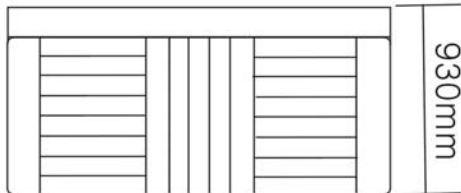
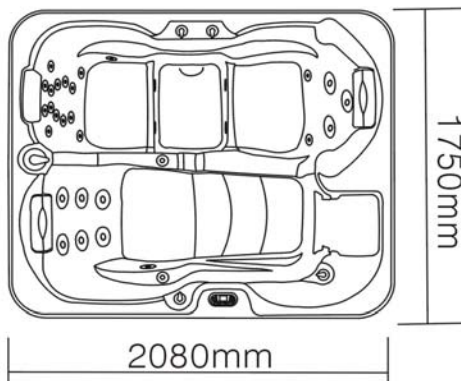
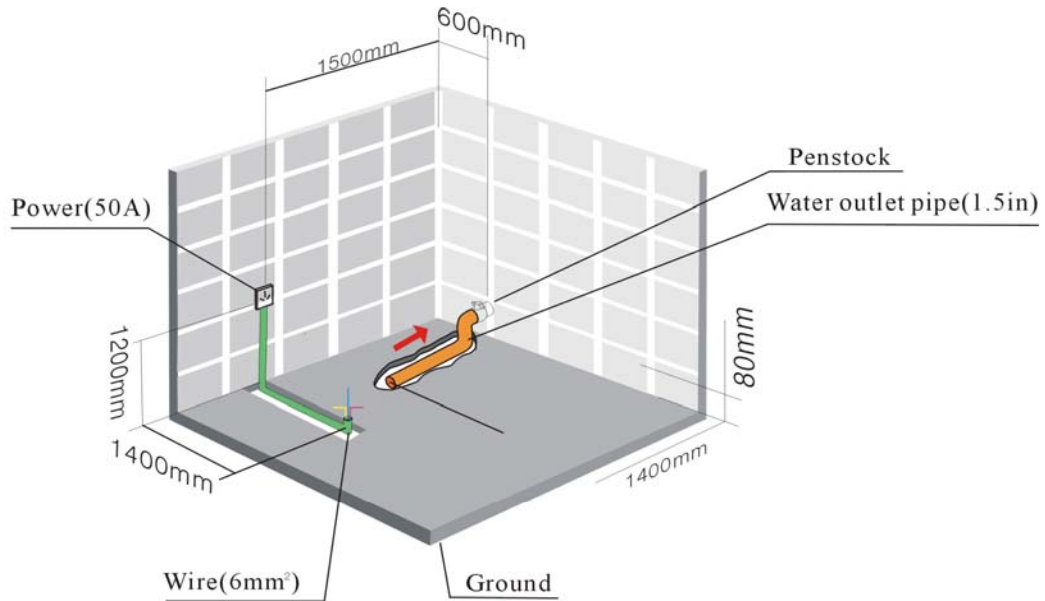

Installation Illustration

- A. Water: It needs two water-galvanized pipes. One is for water resource, another for water outlet. And they should be set on wall, 80mm above from ground,. And a device for cutting water should be set on wall.
- B. Power: The power should be 220V/50Hz, Single-phase, 42Amp The socket should the waterproof, which is designed for bathroom and it should be placed above 1200mm from ground.
- C. The waterspout, whose radius is within 0 to 400mm, should be set at the centre of the osculum. (According to the diagram).

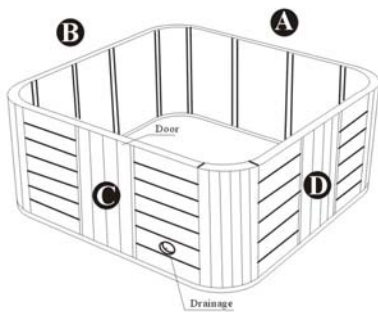

STEP1: Take out the board around the bathtub

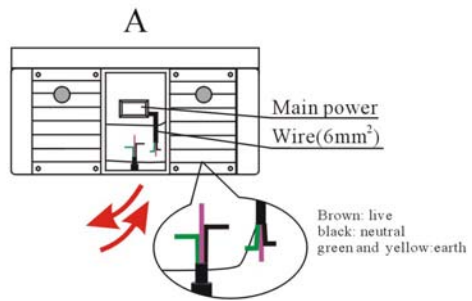

STEP2: connect the main power box to power

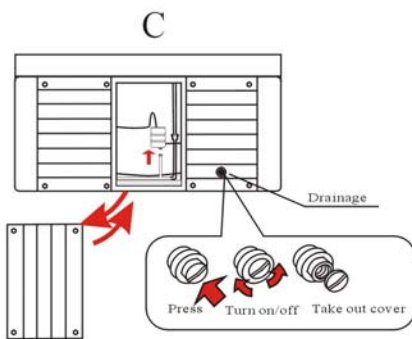

STEP3: connect penstock to the buried water pipe, and then install the board

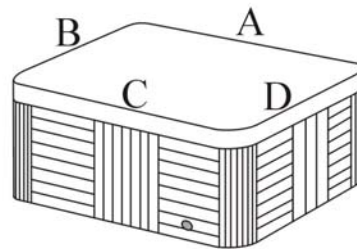

STEP4: finish

Layout setting

